

From Out of "The Ashes" Rises

ZXir QLive Alive!

The Timex/Sinclair North American User Groups
Newsletter

Volume 4 Number 1

Spring 94

Chairman

Ronald S. Lambert

Auburn, Indiana

MEMORY MAP

ADDRESS

- 2 T/SNUG Information and Chairmen
- 3 Input/Output - Help
- 5 M I R A C L E in Newport - 2nd Time Around
- 8 Membership List - Treasury Note\$
- 9 From The Chairman's Disk

ARTICLES

- 11 Oliger Utilities by Don Lambert
- 12 Nostalgia by Abed Kahale
- 13 QL Date Gate by Al Feng
- 14 VU-3D 10 Years Later by Abed Kahale
- 15 LogiCall Review by Abed Kahale
- 16 TS-2068 CMOS On Board by Richard Jelen
- 16 Ni-Cad Charger by Richard Jelen
- 19 TIMACHINE and the FDD System by James Brezina
- 19 QL Video Output Circuit by Richard Jelen
- 20 QL Woes by Nazir Pashtoon
- 22 Moving RAMTOP in ZX-81/TS-1000 by Anthony Oresteen
- 24 ZX-81 POKES & Calls by Anthony Oresteen
- 25 Did You Try This? by Abed Kahale
- 26 MC LISTing for Moving RAMTOP by Anthony Oresteen
- 27 Frustrated PC Users Flood Help Line by Joan Kealy
- 28 D.U.S. Cheat Sheet by Abed Kahale
- 29 Why The Oliger Disk I/F is the Best for the TS-2068 by J. Oliger

SUBROUTINES

- 30 RMG Enterprises Update
- 33 Mechanical Affinity Catalog
- 39 Unclassified Ads
- 42 T/SNUG Public Domain Library Update

Re Up
Time!

ZXir QLive Alive! ©

Established 1991

The Timex/Sinclair North American User Groups Newsletter

Volume 4 Number 1

Spring 1994

T/SNUG Information

T/SNUG

Here is the list of T/SNUG Chairmen and how to contact them. We wish to support the following SIGs:- ZX-80/81, TS-1000, SPECTRUM, TS-2068, TC-2068, Z88 and QL. If you have any questions about any of these fine machines, contact the:-

Chairman

Chief Motivator
Don Lambert (ISTUG)
1301 Kiblinger Pl.
Auburn IN 46706-3010
219 925-1372

Vice-Chairmen

Tape & JLO PD Library
D. G. Smith
R 415 Stone St.
Johnstown PA 15906
814 535-6998

Z-88

Dave Bennett (CATS)
329 Walton St. Rear
Lemoyne PA 17045
717 774-7531

QL & ZX-81 Tape Ed Snow

2136 Churchill Downs Cir.
Orlando FL 32825
407 380-5124

RMG Enterprises

Rod Gowen (CCATS)
14784 Qual Grove Cir.
Oregon City OR 97045
503 655-7484

TS-2068

Rod Humphreys (VSUG)
10984 Collins Pl.
Delta BC V4C 7E6 Canada
604 583-2819

BBS/LarKen

Bob Swoger (CATUG)
613 Parkside Cir.
Streawood IL 60107-1647
708 837-7957

Treasurer

Newsletter/LarKen PD Library
Abed Kahale (CATUG)
335 W. Newport Rd.
Hoffman Estates IL 60195-3106

ZXir QLive Alive!

Is the newsletter of T/SNUG, the Timex/Sinclair North American User Groups, providing news and software support to the T/S community in at least four newsletters per year; mailed on January, April, August, and October.

Our main goal is to keep the Community alive and to provide help when needed.

It is our goal to build and maintain a Public Domain software library and develop a list of available software for all T/S computers crediting the source.

T/SNUG wishes to have one officer from every T/S user group who will take charge of sending us their group's newsletter contents and other correspondence for inclusion in the ZQA! Newsletter.

We encourage your group to copy this newsletter and distribute it at regular meetings to all your members. If you cannot copy this newsletter, perhaps we can provide a disk with the articles on it.

You can keep T/SNUG alive for an annual contribution of \$10 made payable to Abed Kahale. Send check to:-

ABED KAHALE
335 W NEWPORT RD
HOFFMAN ESTATES IL 60195-3106
Phone:- 708 885-4337

Back Newsletter copies are available for 50¢ each postpaid.

Article Contributions

Send in your articles by

tape or disk and your inputs to:-

DONALD LAMBERT
ZXir QLive ALive! Newsletter
1301 KIBLINGER PL
AUBURN IN 46706-3010
Phone 219 925-1372

Or by hardcopy, mail to:- Abed Kahale. (Address on this page)

By BBS:- We now have a 24 hour 300 to 2400 BAUD RBBS. We encourage you to exchange mail and contribute to the download section.

Call the BBS at

708 632-5558

and register. On your next call your security level will be increased to 5 for most of the privileges.

Use extension .ART for articles, .ADS for ads and .NWS for news when uploading. Have fun.

For help, contact the SYSOP by leaving a message, mail, E-mail or phone:

Bob Swoger

(Chicago Area Timex Users Group)

613 Parkside Cir.

Streawood IL 60107-1647

H 708 837-7957 W 708 576-8068

Software libraries, write or call the Vice-Chairmen. When writing, please enclose a LSASE.

Input/Output

by *Abed Kahale*

If you have a question or a problem, why not send it to us. We will try to find an answer and we will all share it. Mail to:
A. Kahale or D. Lambert.
(Addresses are on page 2)

David Lasso of Tucson AZ :- "In response to converting the 2068 to battery power, we should consider what we did 10 years ago in my motor home. We installed an INVERTER, which generate sinusoidal current from DC input. This powered up the AC outlets which, in a motor home, are ordinarily connected to the city lines.

Apparently, higher level consumer electronics require such a current shape, in order to function properly. Otherwise, we could have used a cheap, in-line device, in order to get square wave current in those same AC outlets. We were surprised to find that 30 or 40 hertz current worked just as well as 60 hertz, you know, "50 hertz UK, 60 hertz US".

So, I am wondering if some of my programs, which are not time dependent, wouldn't work just as well in Lancaster UK as in Lancaster PA?"

Your non-time dependent programs will work at the same speed regardless of the line frequency whether it is 40 or 100 hertz. The 'CPU clock' in the computer generates its own frequency (3.5 MHz) and runs off DC. It is not dependent on the line frequency unlike your TV and VCR that do depend on the line frequency for synchronization.

Putting my electrical engineer's hat on, the AC adapter transformer (power supply) is not frequency or wave form dependent, however, the transformer can heat-up and eventually burn if

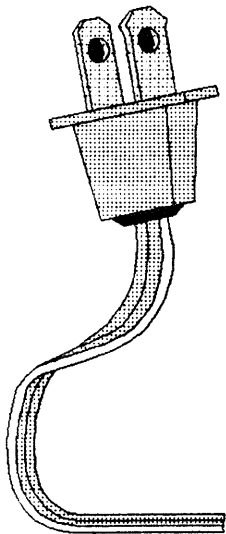

used for an extended period of time at frequencies lower than 50 Hz. These transformers were specifically designed to work with 50-60 Hz AC line. They will work with any repetitive wave form whether it is square, pulse or sinusoidal. As the frequency is lowered, the DC output is lower and the transformer becomes hotter, the opposite is true.

*When it comes to appliances, 60 Hz (sinusoidal) is required if the appliance has an induction motor (such as clothes washer, clothes dryers, air conditioners and some transformless electronics). Appliances with series motors (having carbon brushes) such as food mixers and vacuum cleaners do not care about the line frequency or the wave form. *Abed**

I didn't mean to insult your hero

"Dear Sir,

I am a computer hobbyist. I am interested in classic compact computers including the Sinclair and Timex computers. The trouble is, they aren't the only computers of their kind. They're just the only ones I can find support for. What happened to Spectravideo? Or the Mattel Aquarius? Or the TRS-80 MC-10? The idea that the Spectrum was the first computer with color and sound for under \$300 is a popular myth. The RCA VIP had color and sound for under \$300 in 1980. So did the Protecto Enterprises model "R" level 1.

Where can I find support for these machines? Even the Jupiter Ace is ignored by most Sinclair dealers. Can you tell me where I can get hardware, software, firmware information and other support?

Leon Howell

PS. I didn't mean to insult your hero, by cutting down the Spectrum's reputation; Sir Clive, along with RCA, Netronics, and a very few others, are not ahead of their time; they just aren't behind it like everybody else."

Leon Howell

6150 Monument Dr. Apt. D
Grants Pass OR 97526

Leon had requested and was mailed the
Winter 1993 ZQA!

Dear Leon,

One of the things I learned, in second year
high school science/biology class, is the phrase
“**Survival of the Fittest**”.

The **dinosaurs** didn't have it in them
to survive, they just couldn't **adapt** to the en-
vironment and were very inefficient beasts. The
earth just couldn't support their feeding habits ei-
ther. They were not **fit**; man was the **Fit-
test**. Those who cannot **adapt** are history.

Yes, at the time, I saw an ad about the RCA
VIP. When I asked the RCA representative that
use to call on me about his opinion, knowing that
I was looking for an affordable
home computer, he confidenti-
ally said; “You don't really
want this one! it is an abor-
tion!”. I never heard of the
Protecto nor the Netronics;
apparently they just were not
fit to survive. There is still
some support for other *winners*
like the Tandy, Color Com-
puter ‘CoCo’ and TI-99. I am
afraid that I can't help you with
the others, may be one of our
readers might know about their history.
Anyone out there?

When the TS-2068 (a refined version of
the Spectrum) became available in 1983 for less
than \$200 (I paid \$150), its competitors (Texas
Instruments, Commodore and Hewlett Packard to
name a few) at the time were selling upward from
\$600. To set the records straight, the Spectrum
was offered in the UK for £125, it had a BEEP
and not a three channels sound chip + BEEP that
the TS-2068 has. The ZX-80 was the first com-
puter under \$100, I bought mine in 1979. The
TS-2068 offered more value and features for the
dollar and was easy to **adapt** to. The Timex
Co. was not **fit** in the computer world.
Here are CoCo's addresses:

DAVE BARNES
P O BOX 281
LAKE VILLA IL 60046

G McLEARY
201 - 2512 1ST AVE NW
CALGARY AB T2N 0C2 CANADA

Oked

*[Leon, I didn't remember some of the ma-
chines you mentioned so I asked some of the
older Motorola computer club members about
them. Those that remembered them stated that
they were not considered for ownership because
they were so out classed by the Radio Shack
Color Computer (CoCo) which came out in
1978. Those you have mentioned were all con-
sidered high priced junk and only showed up oc-
casionally in the Chicago area at Toys R Us!
The Radio Shack store managers in the Chicago
area would only stock one
or two TRaSh-80 MC-10s
(a rip-off of the TS1000)
knowing they would not
sell. For this reason you
can not find support for
those other machines,
people just don't form user
groups to support ma-
chines that can't fill their
needs.*

*If SOUND means to
you that the machine had
an internal speaker, OK, but it was only the
Timex/Sinclair 2068 in 1983 that had both a
programmable sound chip and a speaker. Mac-
intosh in late 1984 was the second, I believe.*

*As for the Spectrum itself, I have never seen
one here in the Chicago area but our TS2068s
can run all the Spectrum software just fine.*

*The legacy that Clive left us was a machine un-
der \$100 for people with "EMPTY COAL
BUCKETS AT HOME". These machines didn't
give us "SYNTAX ERROR"s or "ABORT?
RETRY? FAIL?" on the screen all the time, as
the others did, his machines alone understood
DARTMOUTH BASIC, "the original BASIC"
rather than the corrupted Microsoft version!]
---=(GATOR)===*

Timex takes a
LOLICing and keeps
on frolicking.

It is said
that this is the motto of a SIG -
LOLIC (Li'le Ol' Ladies In Computing)
that was started by Joan Kealy of
Brackettville, Texas

David Lassov
of Tucson AZ :-
"Thank you, for continuing to promote the proper care and feeding of Timex/Sinclair machinery.

Your PD Software Library is outstanding, especially the programs by Wes Brzozowski. His articles mentioned the work on 64-character PRINT, without using a cartridge or special ROM, only the two display files. Well, his **PROPORTIONAL PRINT** looks great. They are programs 20178 through 20180.

Unfortunately, Disk # 6 got left out, including PIXEL PRINT PLUS, STING GRAPHICS, QRLKDOS, and RLE GRAPHICS.

KEEP ON TIMEX'n !!!!!!!!!!!!!!!

System Oriented Languages Corp.
2590 N. Jordan Dr.
Tucson AZ 85745-1132"

We thank you for the complements.

*I have to apologize for listing Disk #6 in the Fall 93 issue of ZQA! before actually receiving the disk(s). It turned out to be 4 disks and the QRL LKDOS and the RLE could not be located. Now that I have the disks, please see the description of disks #6 through #9 in the Winter 93 issue of ZQA! [PIXEL PRINT & STING GRAPHICS were mailed to him] *Abed**

Dr. D. H. Williamson of Halifax NS Canada:- "I would like to thank you and to thank a number of other people in both Canada and the US that responded to my inquiries [in UPDATE! Magazine] about upgrading my TS-2068 computer. Bon Chance. (Good Luck)"

Letter that was forwarded to me by Electronics Now Magazine:-

"In the January 1994 issue of Electronics Now, there is a letter by Abed Kahale, The

Miracle in Newport 2nd Time Around

On Saturday, May 14th, 1994, IQLR (International QL Report) will be sponsoring the second annual North American QL/QDOS get together. It will once again be held at the Salvation Army Building on Memorial boulevard in Newport, Rhode Island to the best of our present knowledge. For more information call Bob Dyl at 401 849-3805.

From UPDATE Magazine

Timex/ Sinclair North American User Groups, the letter did not have a mail delivery address.

I would like to contact Mr. Kahale about help in locating software for my own Sinclair TS-1000 computer (specifically a CW - Morse code receiving program) if you can give me his address. If

your Magazine forbids this, please pass this letter on to Mr. Kahale."

Gene Ray WD4GUA
2388 Hwy. 36E
Milner GA 30257

E-mail from Bob Swoger. K9WVY

[One would need an XR-2211 phase-lock loop chip to decode the CW from a four to eight ohm speaker. This chip is available from:

EXAR Integrated Systems, Inc.
750 Palomar Ave.
Sunnydale CA 94086
408-732-7970

Other tone detectors would be possible. A program I wrote for the TS2068 could decode the CW. My program decoded the joystick fire button, the TS1000 would have to decode something else.

I will have to find some other literature to solve the problem in my home library.]

---==(GATOR)===---

Another source would be :-

Alex F. Burr K5XY
2025 O'Donnell Dr.
Las Cruces NM 88001

Alex publishes QZX newsletter "The Journal Covering Amateur Radio & Sinclair Computers". Bob Swoger's address on page 2.

Abed

D. G. Smith of Johnstown PA :- "Where can one get those blank labels for cassettes?"

There are AVERY labels that should do the job for cassettes, they are AVERY numbers 4255 thru 4266. The size is .44" X 3.5", they are called "File Folder Labels" and are available in rolls for dot matrix tractor feed. Another possible: AVERY LSK-3 Index Markers for laser printers, size .5" X 3.13" in 20 per sheet.

TAPE WORLD
220 SPRING ST BOX 361
BUTLER PA 16003-0361

May have the labels with the hole! *Abed*

Wayne Knaust :- "Don, Just a note to wish you a Happy New Year and all that. I have a few needs:

1. I want to buy a 64K RAMPACK (I think that I want a Memopak but I'm not terribly particular). Know of any? Cost?

[Contact Mechanical Affinity. See ad in this issue.]

2. I just acquired a 2068 computer and would like to know if Hot Z, Debugger, Assemblers exist for the animal? I have all these but they are for the TS-1000.

[See RMG & Mechanical Affinity ads.]

I am planning on sending you a potential article on my episodes with the TS-1000 centered around the 32K RAMPACK by Memopak (which was not a good choice). Interested?

I have a lot of Utilities software that I have played with and fixed. Like:

- 64K version of QSave that VERIFYs ZXDB with additional commands
- ZXDB that will locate itself anywhere (well almost anywhere) in core and work not at 16K to 20K.

Are there any of the old 81-83 companies in business, like SINWARE, Bob BERCH, ZEBRA etc. *[I am afraid not]*

I know I ask a lot of questions, if you like just write any answer in the margins and return this

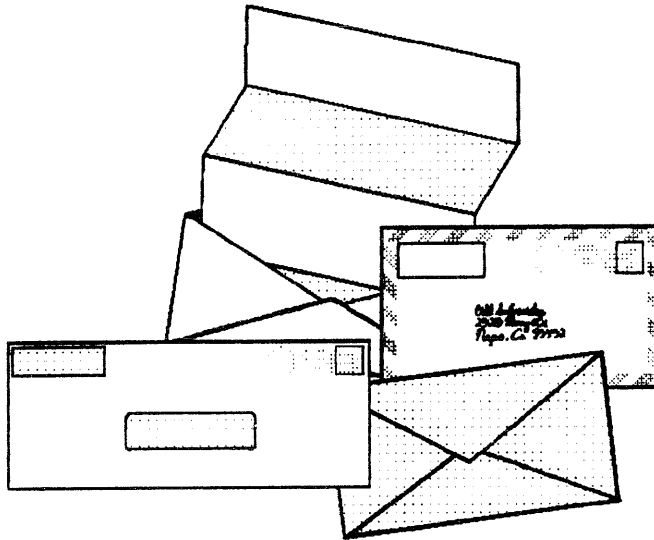

letter. Thank you for any assistance you might be able to give.

PS. Just one more — I am interested in getting a Hunter Board 8K to 16K NV memory for the TS-1000. Any ideas?"

WAYNE KNAUST
2 PEAR TREE CT.
ST. PETERS MO 63376

Help!

Richard Jelen :- "Just got interested again the QL systems I've had stored away since '87-'88 as the heat problems experienced earlier made me leery of depending on the QL system for fun or otherwise. I dragged my old systems out and had to replace the keyboard overlay on one and both worked fine. I am trying to get info. on QL heating modes. etc."

R. A. JELEN
11443 ISLAND RD.
GRAFTON OH 44044
[See article "QL Woes" by Nazir Pashtoon]

Rod Gowen writes: I have sent out copies of the LogiCall disks that you sent me to all who have requested them and the users are quite impressed with the new version. They thank you!

[Thanks for the kind words, Rod.]

---=(GATOR)=---

Robert Shade writes: Please send me all listings of TS-2068 (TIMEX & Spectrum) programs now available in the ZQA Library. All types of programs, games, business, education, graphics, utilities, etc.. I'm interested in acquiring any and all interesting programs.

[Your request has been passed on to Abed Kahale as he can respond much faster to your request. Don't forget to check with Rod Gowen and Frank Davis as to what they have in inventory, we really must keep our vendors Alive! Also.]

---=(GATOR)=---

Welcome back to our community Bob.
[He was mailed the Winter 93 issue that had
the complete listing.] *Ched*

Dave Lassov writes: Thank you for your efforts to keep alive Sir Clive's dream of eight-bit computers. Your coding ideas have saved vast amounts of both time and space in the developed version of Daisy; thousands of bytes and drastic reductions in the delay between computation and line printing. INDEED, there is only a slight delay, due to massaging the line of characters prior to PRINT, since we like BOTH left column AND right column justification.

[Fine business on the elegance of our eight-bit machines. You also are beginning to realize what Sir Clive meant when he reportedly responded to the question of why he chose the Z80 for the Z88 laptop with "I couldn't fine a four-bit processor I liked!" The Z80 has elegant enough architecture for the tasks we require it to do. I am finding that the NEWER machines take more time to get my tasks done and at a higher cost than my TS2068!]--==(GATOR)==--

Gil Parrish writes: Don Lambert had mentioned in recent correspondence that he actually has two spectrum EPROM chips: one a LarKen EPROM fitted in the LarKen DOCK board, the other a Russell EPROM installed internally with a red switch to change from 2068 Mode to Speccy mode. He asked which type I had, since he believes each ROM seems to do better on different pieces of software. I indicated I had a third type, being an EPROM labeled Spectrum V2 FCDB fitted on a Zebra Systems DOCK board. Can you shed further light on this?

[There seems to be four versions of the Speccy EPROM running around here in North America. They Are:- The real Speccy, The Russell which supports TRACE, a means of following a BASIC program execution sequence, the LarKen Spectrum V2 which supports line re-numbering, and the Dohany which is the only one that has corrections for Speccy bugs. If you can't read the label to discover which one you have, do this test in the following order: Type in a three line program using the line numbers 1, 2 and 3. Now type PRINT # 10 If the program is

now renumbered 10,20,30 you have the LarKen Spectrum V2. If not, then type PRINT 1/2 -.5 and if the answer is 0 then you have the Dohany EPROM. If the answer is 2.3283064E-10, you have the Speccy EPROM.]--==(GATOR)==--

Rod Gowen writes: ... surprised to see in NTN what could have been taken as a complaint regarding the fact that someone's name didn't appear on the list of RMG customers that I mailed out to a lot of N/L publishers ... If the person's name didn't appear on that list ... it simply meant that person had not purchased anything or had no correspondence with me since 1991 ... I see no reason to keep a person on my "active user" list if they do not order anything or ask any questions of me.

[Only those since 1991? We at CATUG may have thought of your list as a TIMEX/Sinclair roll-call, but I think there is another explanation, Rod. Time is like a pyramid, the older we get, the faster time goes! Young people think two or three years is a long time ago but us older folks think two or three years was just yesterday. We who were surprised to not find our names on your list were saying, "Didn't we just order something from Rod recently?" The trouble with T/S users/ customers is we have had our machines for over 12 years now and we are forgetting to make a purchase now and then! Please forgive us and thanks for hanging in there for us all these years, Rod.]--=(GATOR)==--

Welcome

Sinclair User Group of WNY XII

Richard K. Norek [Moderator]

188 St. Felix Ave.

Cheektowaga, NY 14227-1228

- TS-2068 is their machine of choice — tape.
- Diagnose and improvise on programs is their main hobby.
- members. - 20
- Established 1983

NOTICE

It seems that it is hard for us folks to recall the last time we paid for membership. Our Chairman wrote me; "... am I paid up? According to the list in ZQA! and my check book, I am not. So here is \$10.00 for me.. Put a prompt on the last issue envelope .. Don Lambert." *Guess he is right, more work for me!* *Abed*

Starting with this issue, your membership expiration date will be after your name on the Mail Label. Example:-

YOUR NAME **APR94** (Expires April, 1994)
 12345 STREET
 YOUR TOWN STATE ZIP CODE

Trea\$ury Note\$

Supporting T/SNUG

		<u>Expiration Date</u>
Paul	Anderson	5/94 ☒
Ronald	Baty	6/94
Dave	Bennett	8/94
Don	Berry	11/93 ☒
Alvin	Bluman	6/94
Daniel	Chattin	8/94
Les	Cottrell	6/94
Jamie	Cruz-Figueroa	4/95
Robert ☺	Curnutt CATS	8/94
Frank	Davis ISTUG	9/93
Daniel	Elliott Computer Classics	5/94
Ruth	Fegley CATS	5/94 ☒
Ferdinand	Gunther	5/94 ☒
Robert	Hartung	4/94 ☒
Fred	Henn	7/94
Fredrick	Hill	2/95
William ☺	Horner	12/94
Glenn	Hufstедler	7/94
Rod	Humphreys VSUG	Charter
Warren	Jackson	1/96
Edward	Jordan	6/94
Jon	Kaczor GCTSUG	8/94
Joan	Kealy	4/95
Quentin ☺	Kent	12/94
Wayne	Knaust	1/95
Jeffrey	Kuhlmann	7/94
Donald	Lambert T/SNUG ZQA!	4/95
David	Lassov	12/94
David	Leech Byte-Back	9/93

Robert	Madaris	5/94 ☒
Lt. Col. Walter	Malin	3/94 ☒
Lafe ☺	McCorkle	9/94
Harry	Miller Jr	5/94 ☒
Frank	Mills CATUG	2/95
Gregory	Newkirk	5/94 ☒
Rchard ☺	Norek SUGWNY	1/95
Gilliam	Parrish	12/94
Jack ☺	Payne	10/94
Hugh	Polley	5/94 ☒
Hugh	Scriven	11/94
Robert	Shade	2/96
John	Shepard	1/95
Greg ☺	Simmons	11/94
Louis	Simon	6/94
Francine	Sklar	12/94
Edward	Snow	5/94 ☒
Dane	Stegman	1/95
Mike	Stephens	7/94
Alexander	Sweitzer	7/94
Ivan	Zachev	12/94
Wesley	Zapotochna	6/94

☺ *Welcome, New Members*

As of April 8, 1994 we have a balance of
\$396.34

Abed Kahale Treasurer
The Timex/Sinclair
North American User
Groups

It's Re-Up Time

for those who did not

FROM CHAIRMAN'S DISK

Donald S. Lambert

January 9th.

In trying to get Spectral Writer converted from the Oliger interface to LarKen I ran into a problem. Or should I say several problems. First one is that the EPROM for SPECTRUM on the LarKen disk board will not work with the Oliger disk interface or else there is something that I don't know. The system will not come up. So I had to use the computer with the internal RUSSELL version of SPECTRUM. Then I did find out that while I changed the LOAD/SAVE lines to LarKen that in practice they did not work. The program would SAVE using SPECTRAL WRITER's SAVE program option but after that it would not work. If you left the menu for any reason you could not return. Then I found (rather Bob Swoger found) that some lines were changed in the process of the SAVE. So that is another problem. And if you used the NMI/push button SAVE it did not help either although it was better than the SAVE by way of the SAVE option in the menu.

And with the program LISTed to the screen with the Russell SPECTRUM it seems to list it with no (or fewer ?) errors but with the EPROM on the LarKen board it gives lots of errors. Is there enough difference that they are not compatible?

I realized that there are a number of T/Sers out there who still work with the cassette mass storage system and for various reasons can't or will not change to disk systems. With the TS-1000 there are no new ones still available on the market so the only way to go that route is to find a used unit. With the TS-2068 there are a number of different units that might be found used but there is one that is still available from J. Oliger Co.. But that does not help those that are not interested or can't afford a disk system. However, working with the cassette is frustrating since programs are put on the tape serially and you have to go through all the others to get to the one on the end. I had developed a way to avoid that with my TS-2068 and TS-1000 before I got involved with a disk interface with either machine.

The article I worked on back in 1989 was written when I was first trying to get started with a disk

interface and I did not have my favorite word processor converted to disk. What I was using was the LarKen floppy disk interface on the TS-2068, the way I got around the built in cassette LOAD/SAVE was to use the NMI button and force a SAVE of everything in memory. While it worked, it did use up 10 tracks of disk space. To get the files out to edit them and to also be able to send the files on disk to Abed Kahale, I had to get them SAVED as a file. So I broke the program (MSCRIP) and LISTed the program to find where the file LOAD/SAVE was in the program, then accessed the program and changed those lines to the LarKen floppy disk commands so that I could SAVE them to disk as files. However, sometimes when the files were LOADED as NMI, I got scrambled screens in which the characters were changed.

Here is a sample of what it looked like:

```
MCITC madMn      eoyug 41
pedaocmn  dcae  eoyfe 18
hnefn tig  sm]   idwwda 6
idtx tig  tig    Cmad?_
```

However, when it does that, if you press CAPS SHIFT and SYMBOL SHIFT plus the H key gets you to the menu and into the correct lettering for MSCRIP. Occasionally it will get hung up and it is locked out of control, in that case try a reload of the NMI program.

The LarKen system, even using the NMI button to SAVE the word processor and the text file was so much better than the cassette system that I used it that way till I learned to add the LOAD/SAVE routine to the cassette version (V5.0) of MSCRIP that I was using. Later I added the V5.5 and really got going. I also have the V5.3, which I have not used since I use the V5.5 all the time.

The more I used different programs from the Disk Utility System by Kristian Boisvert the more I learn just how valuable the disk is for LKDOS users. I will have to recount some things that can be done with that disk.

But the big problem has been the weather. I guess I am getting cabin fever and some days (when the temperatures are in the 0 range) it is too cold for

me in the computer room. I guess I am not a lover of cold weather. But what choice do we have, it is either being cold or facing the fires, the floods or the shake rattle and roll of our western state. No place is perfect in all ways.

Here it is February 27th and we have been through several winter storms and I was prevented from attending the February 26th meeting of ISTUG in Indianapolis not by the snow on the highway but by the snow in the driveway. By the time I got the driveway cleared it was too late to go even if I had planned to go. Masako and I had decided that the weather was not the sort to make a 150 mile one way trip.

I have ordered a used AERCO 2068 floppy disk interface from Mechanical Affinity and I will be messing with that later on. I have a pair of drives that were set up for the AERCO ZX81 floppy interface and I will see if they will work with the 2068. According to an AERCO manual that I have they should. However, different versions have different options. Wait and see what I get. I bought a version that had 64K on the interface board. But it can be upgraded to 256K if needed to be. More about that in the future.

Last week I received the AERCO floppy disk interface for the TS-2068 and it was the 64K RAM version. If and when I decide, I can have it modified to 256K since the manual details how to do it. It does work since I managed to FORMAT a disk and then COPY the BOOT disk to the newly FORMATTed disk. I also received the BOOT disk for RP/M which is a version of CP/M. Reminds me of having the SPDOS for converting the Oliger disk system to the Millenia K system. And since the DOS of the AERCO is different I will have to relearn a lot of commands. I will be able to give more information after I have a chance to play with it more and that will be after I send all this material to Abed Kahale to make up another issue of ZXir QLive Alive! [You did a fine job Don *Abed*]

Found an ad listing ZX-81 prices amongst other things in the 1980's (I think 1982) and the prices were enough to take your breath away. The ad might be run if there is room.

1982 Japan →

D. G. (Smitty) Smith writes "The ZX printer can't use thermal paper, it must have the aluminum coated paper. Radio Shack Quick Printer paper will work." (*Don- Seems I read that thermal paper will ignite in the ZX printer but I am not sure if it will*)

There is a new concept on batteries that RAYOVAC has marketed. Basically they are rechargeable alkaline batteries. Should be a cheaper way to go with the laptops since the alkaline Renewals have greater capacity than NiCad. I have a data sheet on them but it does not list the data as I wanted to see it displayed. I will include some material on them if I get it figured out. Mr. Richard Jelen is working with them, see his letters.

I did remove a heart stopper from my working TS-2068 computer. And that is the little blue slide switch on my Russell ROMSWITCH. That little magnet will definitely erase a disk if it is laid on it, I pulled off the magnet and put it where (I hope that I can find it again) but not near any disks. The disk that got crashed was one that I had a back up copy of. It does pay to have backup copies.

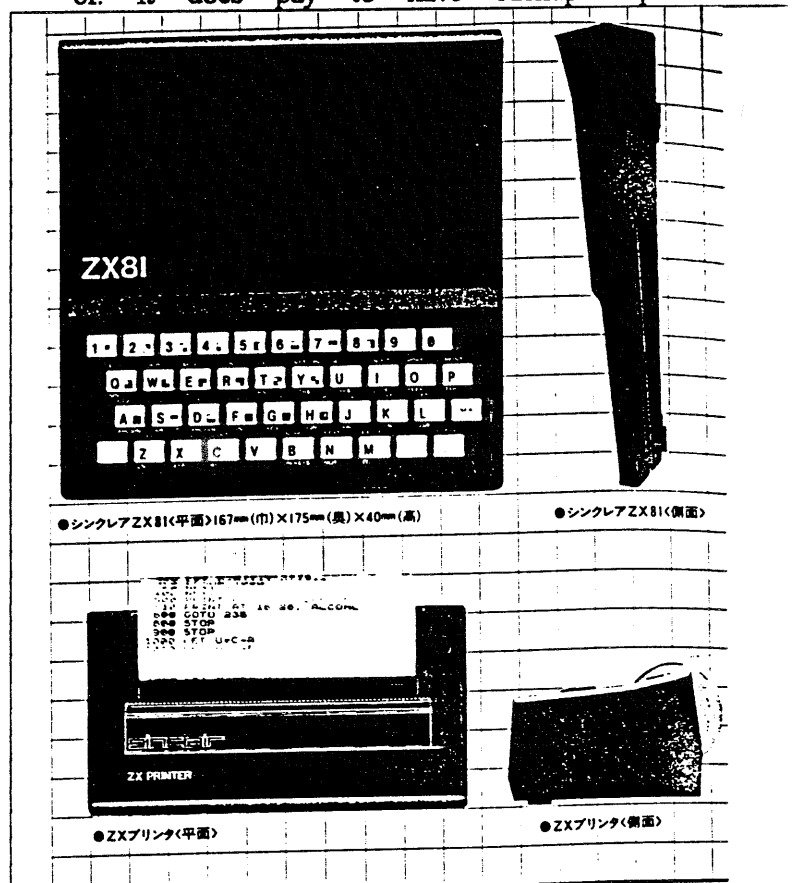

X81 (シンプルプログラム時代を)

取る、純化ともいべきひとつの結晶) ¥38,700

OLIGER UTILITIES - Software

by Donald S. Lambert

I thought that I would give a sort of review and step through manual for DISK FILE MANAGER which is an Oliger utility. So far as I know there is not a manual for this software that is in public domain. The program is all in BASIC and occupies 10,022 bytes so for those that want to improve or change it and are programmers it is easy to do.

DISK FILE MANAGER LOADs with a report of "0 OK, 601:1" and either RUN or GOTO 1 will initialize it. First screen prompt, "Source Drive?"

Enter that and get prompt, "Destination Drive?"

Enter that and get prompt, "Is Above Correct?"

Enter "Y" for yes and get the menu. NOTE: if you have the T/S 2040 printer plugged in and turned on when you do "LOAD DRIVE ? CAT" (? stands for the drive you selected for the Source drive) the printer will PRINT out the CAT of the source drive. This is what the menu looks like:

Disk File Manager

```
LOAD DRIVE 0 CAT
INDEX AND SAVE
MOVE FILES
LPRINT DRIVE 0 CAT
FORMAT ANY DRIVE
RENAME FILES
RESTART ME
QUIT ME
```

To select the options use the space bar to move the cursor downward only. If you overshoot then it will jump to the top when it reaches the bottom. To select a cursor marked selection hit the ENTER key.

MOVE FILES is a copy option. It will copy the disk in Source Drive to the destination drive. The drives do not have to be the same (40 track to 80 track or the reverse but of course the copy terminates with disk full prompt). To copy LOAD source drive's CAT, in other words hit ENTER with the cursor on LOAD DRIVE ? CAT and it will LOAD the

CAT and step through the files and then ask SORT? (sort into alphabetical order) N will get you back to the MENU or Y will sort the files and then it will get back to the MENU. Move the cursor down to the MOVE FILES option and hit ENTER. You will get a prompt "Have You LOADED the CAT?" If N for no will return you to the MENU. If Yes hit Y and ENTER and then the CAT will be displayed on the screen with the cursor on the first entry. If you want to MOVE that file hit the ENTER key if you want to skip moving it hit the SPACE BAR. If you want to MOVE (copy) all files just hold down the ENTER key and it will step through and will also start the copy procedure. When all entries are marked or skipped then the prompt: "Place New Disk in Drive ?" and a flashing prompt: "Hit ENTER TO MOVE Files ?". When that is done the drives get busy MOVEing the files from source drive to destination drive. Finishes with prompt: "Hit ENTER for MENU"

In addition to MENU you get a report of how many cys FREE in each drive.

INDEX AND SAVE: CAT must be LOADED. It SAVES as disk name and type as "disk name C ARR" but I don't know what to do with it. I could not LOAD it again. (Anybody know?)

LPRINT DRIVE? CAT: if CAT not LOADED gives ERROR: "2 variable not found, 580:1" This outputs to a large printer, I needed to add a line advance since it all printed on one line.

FORMAT ANY DRIVE: CAT does not need to be LOADED. First prompt: "Which DRIVE? (0-3)" When drive entered get second prompt: "TRACKS/INCH: 40/80" I entered 42. Third prompt: "Is the above correct?" If N is entered goes back to ask "which drive?" If Y get fourth prompt: "Name for Disk?" You are allowed 16 characters (I know that you LarKen users are crowing since with the LarKen you can almost write a book but on the other hand the Oliger allows any ten

characters for a file name instead of six a period and mandatory type plus one more character) and after name is entered and you hit ENTER the FORMAtting starts with the following prompts: below prompt for name is displayed the disk name you entered and at bottom is displayed "FORMAtting" and again gives disk name. I modified my working copy of DFM ABC so that it stops when FORMAtting is complete. Otherwise it flashes very fast the directory of the disk and back to the DFM ABC menu. In line 960 there was a PAUSE that I changed to STOP that I wanted for personal reasons. To return to menu on my version I hit CONT. and ENTER.

RENAME FILES: CAT must be LOAded. Selected file(s) will be prompted: "RENAME File Name to?" and then after that

is entered get prompt: "Correct?" If correct the disk drive will operate and other file names will be presented till all are processed. When all files are done prompt: "Hit ENTER for MENU" appears.

RESTART: Goes back to start of DFM ABC in other words to enter source drive and destination drive.

QUIT ME: gets: "9 STOP statement, 150:2.

I had DFM ABC for quite a while before I started to use it and now I use it to FORMAt all my Oliger disks. The main reason for that is the Oliger EPROM that I have is version 2.64 and the default is to 80 tracks. This way I don't have to remember to change the track from 80 to 40 (LET /T=42) each time I use it. 0/0

Professional performance for only £125 - how's it done?

Quite simply, by commitment and design. Timex and ICL are adopting Sinclair technology and Sinclair BASIC under licence for future products. Sinclair is now world leader in personal computer production.

\$99.95 Complete kit

Special offer to EE Times readers.

You've probably seen our ads on the ZX80 personal computer for only \$199.95. Just to remind you what a good buy the ZX80 is, we've reprinted the ad on the other side of this page.

Now we have an even better offer. If you order within 14 days, we'll send you the ZX80 in kit form for just \$99.95. That's a savings of \$100! You'll be able to assemble the computer yourself in just a few hours. We'll send complete instructions along with a 128-



1979

IBM-PC Capacity at a Fraction of IBM'S Price!

New NETRONICS 16 Bit EXPLORER 88-PC Kit starts at Just ~~\$399.95~~ - Accepts All IBM Peripherals.

- the power of the processor which my program costs only \$399.95!
 - IBM compatible keyboard...\$299.95 + 10.00 p&I.
 - IBM compatible color board...\$299.95 + 10.00 p&I.
 - Additional ROM required...\$35.00.
- to learn 16-bit features: Set your own pace! Invest and learn at the rate YOU want! Add to your EXPLORER 88-PC: Deluxe heavy-duty steel cabinet that houses either two 5 1/4" floppies or a 5 1/4" hard disk

Special IBM compatible system: with keyboard, color graphics board, floppy disk controller, 64K RAM, cabinet, standard power supply and a single 5 1/4" floppy drive... \$1899.95 + 25.00 p&I.



1982

12

FOCUS

The Largest Authorized Computer Dealer in Brooklyn
Our 16th year in Electronics!
Our policy: lowest prices, prompt service, satisfaction guaranteed!

Computers Peripherals & Software 1983
ATARI

Huge amounts of IBM Apple Acc. and software at low prices	Atari 1200XL 64K	659.95
	Atari 800 w/48K	439.95
	510 Disk Drive	439.95
New Model Aquarius with C/P/W	call	
NEW Panasonic Computer w/32K B.G.B.	Atari 400 w/16K	199.90
	410 Recorder	73.95
	Programmer Kit	49.90
	Atari joystick	7.95

EPSON

NEW! MX-20 Portable	in stock for immediate pickup	call
NEW! FX 80 printer	call	
MX 80 II	for FX 200 Scientific	24.90
MX 80 w/ F/T	deal	
MX 100 II	93.95	
Compaq 17 green monitor		

HEWLETT PACKARD

NEW HP 75C	\$789.95
HP 410X	234.95
HP 41C	144.90
HP 16C Programmer	89.95
HP 15C Scientific	89.95

COMMODORE

HP II Accessories low price	Commodore 64 complete	399.95
	VIC 20 with RF	138.95
	1541 Disk Drive	324.90
	1510 Recorder	63.90
	call	
	NEW! 1525 Printer	119.95
	VIC 3 slot expander	32.95

SHARP

Full line of TI software in stock	PC 1500 with CE150	299.95
Times TS 1000	CE 158 RS 232 (for 1500)	159.95
	CE 159 BK w/battery	119.95
	call	
HP RAM: Original Times	NEW! PC1250	call
Times Printer	PC CE 125 Printer and micro cassette	call
Times Frogger	PC 1211 with CE 122	99.90
Full line of Times software in stock		

COMMODORE Computers

TEXAS INSTRUMENTS

SHARP

COMMODORE Computers

PAPER * MATTEL * ROMATA * FRANKLIN * HEWLETT PACKARD * TINES * IBM * ATARI

QL DATE GATE!

Making Modifications to DBEASY by **Al Feng**

DBEASY by *Bill Cable / Wood And Wind* is a program which I appreciate more and more each time I use it. As Bill notes in his documentation, it is open to the user and readily available for modification.

The only difficulty with this statement is that I would hazard to guess that the average DBEASY user does not know how to make any modifications in an ARCHIVE based program.

The following is the simplest of changes, but after seeing how easy it is to implement, you may be encouraged to make some of the other changes that may have come to mind.

An aspect of DBEASY that I wanted to change was the presentation of the date on the MAIN MENU screen from year/month/day to the standard American format of month/day/year.

```
Proc heading
paper spap: ink sink: cls: paper hpap:
  ink hink: print rept(" ",240)
let i$=time()
let i=val(i$(1 to 2))
let j=60*i+val(i$(4 to 5))-smin
      rem the following is the old line
print at 2,1;upper(sys$);" MAIN MENU";
  at 1,42;today$;tab 54;"day " ;day;
  " of 19";val(today$); at 2,42;time();
  tab 54;j;" minutes since start":
  print ; tab 80
paper spap: ink sink: if begcnt=-1: let
  I$="-": else: let i$=str(begcnt, 2,0):
  endif :
  print at 5,1;upper(sf$);
print at 5,48;"Module      : " ;mod$:
  print at 6,48;"Programs on : " ;pd$:
  print at 7,48;"Database   : " ;sd$:
  sf$;".dbf";
  at 8,48;"Records      : " ;I$: print
endproc

proc heading
paper 7: cls: paper hpap: ink 0: print
  rept(" ",240)
let i$=time()
let i=val(i$(1 to 2))
let j=60*i+val(i$(4 to 5))-smin
      rem the following is the changed line(s)
      [American date format]
```

```
print at 0,42;today$(4 to 8);"/";
  today$(1 to 2); tab 54; "day " ;day;
  " of 19";val(today$): ink 7: print at
  1,1;upper(sys$);" MAIN MENU"; at 1,42;
  time();tab 54;j;" minutes since start"
paper 7: ink sink: if begcnt=-1: let
  I$="-": else : let i$=str(begcnt,2,
  0): endif : print at 4,1; upper(sf$);
print at 3,48;"Module      : " ;mod$:
  print at 4,48;"Memory : " ;memory():
  print at 5,48;"Program on : " ;pd$:
  print at 6,48;"Database   : " ;sd$:
  sf$;"_dbf";at 7,48;"Records : " ;i$;
print at 8,48; "Screen      : " ;scn$;
endproc
```

Use the following if you prefer day/month/year:

```
print at 0,42;today$(7 to 8);"/";
  today$(4 to 5);"/";today$(1 to 2); ..
      or
print at 0,42;today$(7 to 8);"/";
  today$(4 to 6);today$(1 to 2); ...
```

Perhaps the easiest way to implement this is to:

- a) EXEC_W flp1_ARCHIVE
- b) type "edit" ENTER
- c) proc heading ENTER (type in the second example)
- d) SAVE "flp1_this"
- e) RUN "DBEASY"
- f) Exit program by pressing (esc) when prompted whether or not you wish to quit BEASY
- g) type "merge flp2_this" ENTER
- h) type "start" ENTER
- i) verify appearance
- j) exit program
- k) SAVE object : "flp2_DBEmm"

OF course, you can edit directly within your current version of DBEASY, if you like.

This reminds me of a LOADING tip. Presuming that you are using the standard version of ARCHIVE (vs. From within XCHANGE), you can save a few key strokes and hand movement if you:

RENAME flp1_DBEASY_prg to flp1_R_prg

Then after you EXEC_W flp1_ARCHIVE, you simply have to INPUT:

RUN ENTER R ENTER

Your left hand should (will) already be poised to press 'R'; so, some effort should be saved. Of course, you may opt to select a different single_key other than 'R' if you choose.

NEWS YOU CAN USE

by **Al Feng**

For those out of the mainstream, like myself, you may like to know that

Miracle Systems Ltd.

25 Broughton Way

Osbalwick, York YO1 3BG UK

has recently announced/demonstrated their Super Gold Card [£325 + vat {UK residents;}].

The SUPPER GOLD CARD uses a 25 MHz. 68020 (vs. 68000) with 4 Mbytes of memory.

There is a trade-in policy which is very generous, and I would definitely put this at the top of my things to do/get list if I had not just gotten a replacement, INGOT5 chip which corrected the speckled screen syndrome which plagued many of the older GOLD CARDS.

If you have an original GOLD CARD which is still experiencing any unstable video output, then you should write to Miracle and request a replacement chip. The replacement chip is free, just describe your ROM's version number, the CARD {color} and the problems you are experiencing.

If you cannot afford a new SUPPER GOLD CARD, Miracle is "recycling" the soon to be returned GOLD CARDS for only £150 (about \$225). This is a very good deal.

HAPPY TRAILS,
AND COMPUTING, TO YOU

VU - 3D

10 YEARS LATER

by *Abed Kahale*

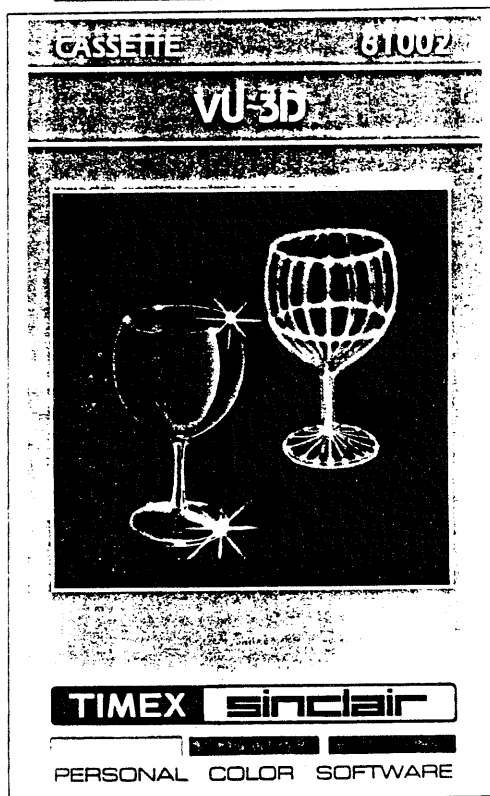

I bought my TS-2068 and VU-3D among other programs in 1983. Proud of my new computer, I took it to the office to show-and-tell my coworkers.

A couple of weeks later, the boss called and advised that I am to give a *command performance* with the VU-3D to no less than our

General Precision and Link Simulator divisions who were involved in the space program at that time. What happened is, somehow, our Corporate big wigs learned of my VU-3D and got the notion that they now can have a CAD (Computer Assisted Drafting) on every desk.

I did feel like an imbecile demonstrating to the *top brass* what the program could NOT do and why it was NOT meant for engineering use, instead of how great it was. After the demo, one of them said;

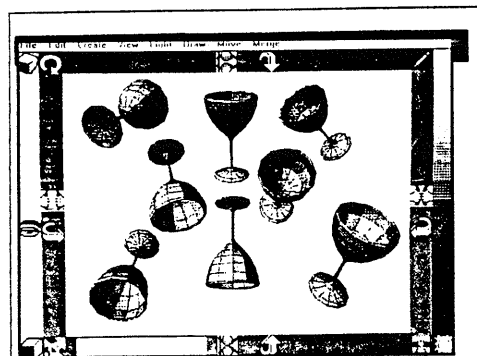

You'll have over 2,500 3-D images that you can show from the front, back, sides, top, bottom or any-angle to create a virtually infinite number of images.

Or, order 3 or more CD ROM programs and grab Clip Art 3-D for just \$39⁹⁰ (\$4 P&H). Use Special Order No. 3700.

believed for a moment that a \$14.95 program was going to revolutionize engineering. Thank you for letting us have a peek at what the future will bring for the masses."

LogiCall Review

Auxiliary Operating System AOS-LKDOS

by *Abod Kahalo*

Developer: **Bob Swoger**

LogiCall contains all the commands required to run LK-DOS (TS-2068 & Spectrum). It prompts for a command and executes these commands with a minimum of typing.

Moves from drive to drive with 2 keystrokes; moves into and out of a word processor, database, spreadsheet, terminal program and other programs using a few keystrokes. Displays word processor files and pictures on the screen without running any program. FORMAT, MOVE, ERASE, CAT, POINT, and VERIFY keys all work without the use of the "RAND USR 100: or PRINT#4: " that have to be typed using LKDOS alone. It really proves itself with multi-drive system and will be of great benefit even with a single drive. And, it is not memory hungry, it only occupies one disk track. It does complete the LarKen Disk Operating System.

LogiCall comes in two versions, 5.0 for all including ROMSWITCH and 5.2 for Spectrum ROM in the doc port. OUT 244,3 is not required.

A complete file management system, more accurately a HUMAN INTERFACE (you and the machine) shows the years of refinements.

Holding down the ENTER key (or the ENTER and the 'J' keys for the RAMDISK) at power up, displays the CAtalog and the Drive? prompt. ENTER the disk drive number or 'T' for tape or just ENTER to display the Program? prompt.

ENTERing 'H' or '?' at either prompt, displays two screens HELP menu.

ENTERing one of the following at "Program?"

'9' displays CAtalog.

'V'erbosE displays the complete CAtalog.

'B'rief displays a CAtalog that only shows programs that can be LOAded and RUN.

'N' at the scroll? displays the Program? on CAtalogs that scroll off the screen.

'W' LOAdS word processor.

'T'erminal LOAdS terminal program.

'5' or '8' RENAME "old", "new". ENTER the NMI-S2.CM to be renamed, then the new name.B1.

'7' or 'E' RASE - ERASE ".....". ENTER the filename and extension.

'A'dds AUTOSTART to a disk.

'S'ave SAVES "L.B1".

'Z' COPYs to the TS-2040 printer.

'C'OPYs to a large printer.

'N'ew activates AUTOSTART again.

'0' or 'F'ormat LOAdS FORMAT.B_

'6' or 'M'ove LOAdS MOVE.BL

'R' VERIFYs the disk for CRC errors.

'K' SAVES SCREEN\$ to disk.

'Q'uits or 'E'xists to BASIC where the program can be customized.

'0, 1, 2, 3 or 4' moves between drives.

At the Program? prompt, hitting ENTER without typing a filename activates the SCAN LOAD mode. The space bar or any key in the lower key rows advances a BRIGHT BAR down the screen, the top row of keys will send the BRIGHT BAR back toward the top. ENTER LOAdS the BRIGHTened program. The arrow keys do work as normal or without shift.

ENTERing a name with an extension of '.C\$' at the Program?, LogiCall displays it as a SCREEN\$. While ENTERing a name with an extension of '.Cm' or '.CT', it displays MSCRIPT, TASWORD II or SPECTRATERM word processor files directly from disk.

LogiCall disk ensemble includes VUFILE, VUCALC, TASWORD II, disk/tape records base and MTERM II among others.

It is like an upgrade from a gear-shift to an automatic transmission with overdrive.

LogiCall is available from RMG Enterprises and from Mechanical Affinity.

TS-2068 — CMOS ON BOARD

by Richard A. Jelen

Letter dated 11-12-93

Earlier this year I finished repairing the three 2068 mother boards, I bought last year, with the help of the gentleman from "COMPUTER CLASSICS" in Cabool, Mo. Seems all the SCLD's had been zapped on the A7R (REFRESH), along with much memory and multiplex damage. He showed me how to rebuild the SCLD REFRESH circuitry without replacing the SCLD. Naturally, it worked great and I was so impressed with him I bought a 286 PC he had advertised, which also works great I might add. My wife and children use the 286 for greeting cards, etc. They're tickled pink and even though I don't use it much myself I feel it was well worth the investment.

This spring/winter I changed one of the repaired 2068 mother boards over to all CMOS, except for one EPROM, and managed to reduce power consumption to 150 ma.! The original 2068 draws about 250 ma. which is even less than the TS-1000 @ 270 ma. that I made into the Ni-Cad portable, which gave me almost 6 hours running time on 1.6 AH 'C' size Ni-Cads. With the 150 ma. rating on the 'CMOS' 2068 I'll be able to get 6.5 hours run time using .85 AH "AA" size Ni-Cads which is great and cuts size and weight.

CMOS — 2068

DESIGN	JAMECO #
U3 = Z84C00-4	35781 @ \$3.75 ea.
U21 = 74C00	45161 @ \$0.29 ea.
U15 = 74AC245	45671 @ \$0.69 ea.
U9 = 74AC245	45671 @ \$0.69 ea.
U5 = 74HC244	45655 @ \$0.69 ea.
U10 = 74HC257	45719 @ \$0.55 ea.
U11 = 74HC257	45719 @ \$0.55 ea.

(Sub. for 74LS/HC157 as tri-state not used or needed)

U16 & U20 ROM's — I managed to get the XROM from "COMPUTER CLASSICS" in Cabool, MO but though he tried he couldn't get a CMOS home ROM to work. The XROM cuts power consumption an additional 12ma. (Every little bit helps). Original 2068 = approx. 250ma., CMOS 2068 (as above) = 150ma., - bear in mind that probably nothing can be done with the U4 (LM1889) and U14 (AY-3-8912) unless you just remove them?

The only other CMOS to be tried will be the home ROM if I can get one and the 4416 dynamic RAM's substituted to 62256LP12 CMOS static (maybe).

CMOS ↔ Complementary Metal Oxide Semiconductor

Ni-Cad Charger

R. A. JELEN

11443 ISLAND RD
GRAFTON OH 44044

Letter dated 11-28-1993.

Nice to hear from you so soon and thank you for the disk info and program, though it will be many months until I get it all together to assemble all the interface parts, I do appreciate your help. Yes I would like the disk drive P. S. Printout. I will probably start out with 2 ea. IBM style (8088) drives @ 5.25" and 360K DSDD.

As for your request to publish my LOADER schematic, certainly, as long as I receive due credit, maybe a mention that they may write to me (with large SASE) for more info: such as PC artwork negative and assembly & test instructions. This also goes for any other info: schematics, etc. I may send you in the future.

I've enclosed a marked up constant current charger for the TS-1000 system I made. (Mine also included a charger for the Monitor battery pack which had to be separate since the voltages were quite different). Also, the monitor draws loads of current so I had to double the Ni-Cad pack for it to get enough time.

Circuit drawings.

For this design (a non-constant current) the D. C. Power pack must be at least twice the voltages of the series Ni-Cads (in this case 2 ea. 1.2V Ni-Cads = $2.4 \times 2 \Rightarrow 5V$ it must also be capable of twice the charge rate for the Ni-Cads (in this case the charge rate is 100ma., so the 5V D. C. charger must be capable of 200ma. or higher. This is in case the Ni-Cads happen to be shorted in which case all power is dropped across R1 and the power pack will remain unharmed. R1 value is figured by first determining the desired charge rate for B1 (*please note most Ni-Cads especially the older ones have upper limits to their max. charge rate and the user should determine this before attempting to charge any Ni-Cad*). In this case, we've chosen 1.2 AH Ni-Cads and its safe to charge them @ 100ma. (I don't know of any standard rule of thumb for all Ni-Cads AH's rating vs. safe max. charging rating). This D. C. power pack is 5V D. C. @ 200ma., however, since we are charging @ only 100ma. the 5V D. C. output will be probably be around 6V D. C. since its RMS. Full output will be near 7V. Our cells are about 2.4V subtracted from 6V = 3.6V that R1 has to drop @ 100ma., so R1 should be 36 ohm @ .5 watts minimum (1 watt would prevent burnout of R1 if the Ni-Cads short).

If we choose a std. 10ma. LED for LED1 we will run it at 5ma. (because if Ni-Cads short it will then become 10ma. and won't burn out). So we have 3V drop across R1 minus the LED drop (which can vary between 1.5 and 2.2V depending on the LED type) so we'll choose the lower value

(unless you test the LED you are going to use) to further protect the LED (Only slight brightness will be sacrificed) of 1.5V which equals 2.1V to be dropped by R2 @ 5ma., so R2 equals 420 ohm (390 ohm would be OK).

LED1 will only light if the power pack is plugged in and Ni-Cads are connected (to load R1). However, if Ni-Cads are shorted there is no way of knowing unless you add a circuit to monitor the Ni-Cad voltage, etc.

Like I said, this is the cheapest way to go but the batteries charge is slightly linear, which is for most Ni-Cads, trickle charging is "OK".

Letter dated 12-20-1993.

Nice to hear from you again. Thought you might be interested in the latest developments in alkaline batteries. Not long ago I saw a commercial on TV RE. a battery charger for standard alkaline batteries which allowed 25 ea. full recharges. Now, I just happened to see this ad in my wife's ENTERTAINMENT WEEKLY magazine. To me, it looks the way to go. They are now available in stores and I've priced the chargers @ \$17.00 - \$29.00 (29 is for a charger that will handle either 4 'AAA's, 4 'AA's or 4 'D's and the batteries are about what you'd pay for a Ni-Cad equivalent).

At lower current draw I suspect results as quoted in this ad, but at higher currents such as toy motors, portable fluorescent lights and your disk drives I believe Ni-Cads may prove better — but it needs to be put to the test. The biggest plus is that once recharged they will hold full charge for 5 years just like a new alkaline. This I think is great.

Here's a very simplified Ni-Cad charger as used in many small Ni-Cad power tools such as screw drivers.

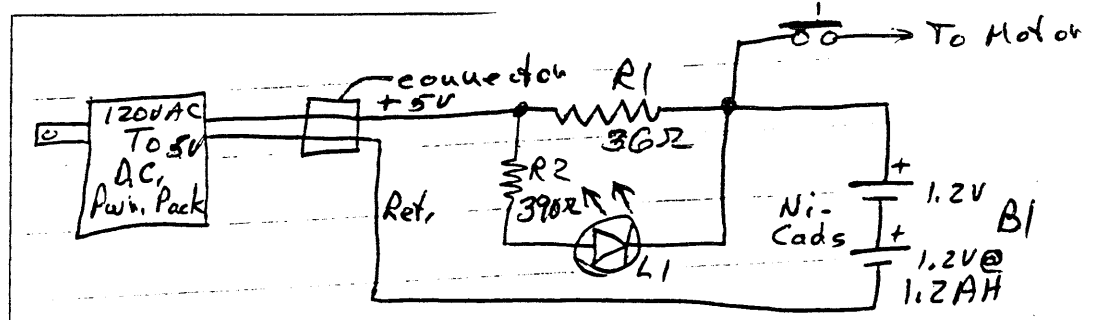

T/S ~~1000/1500~~ ²⁰⁰⁰ Ni-Cad Power Supply and charging system

CAUTION: Charge time 13 to 14 hrs, Do Not Overcharge

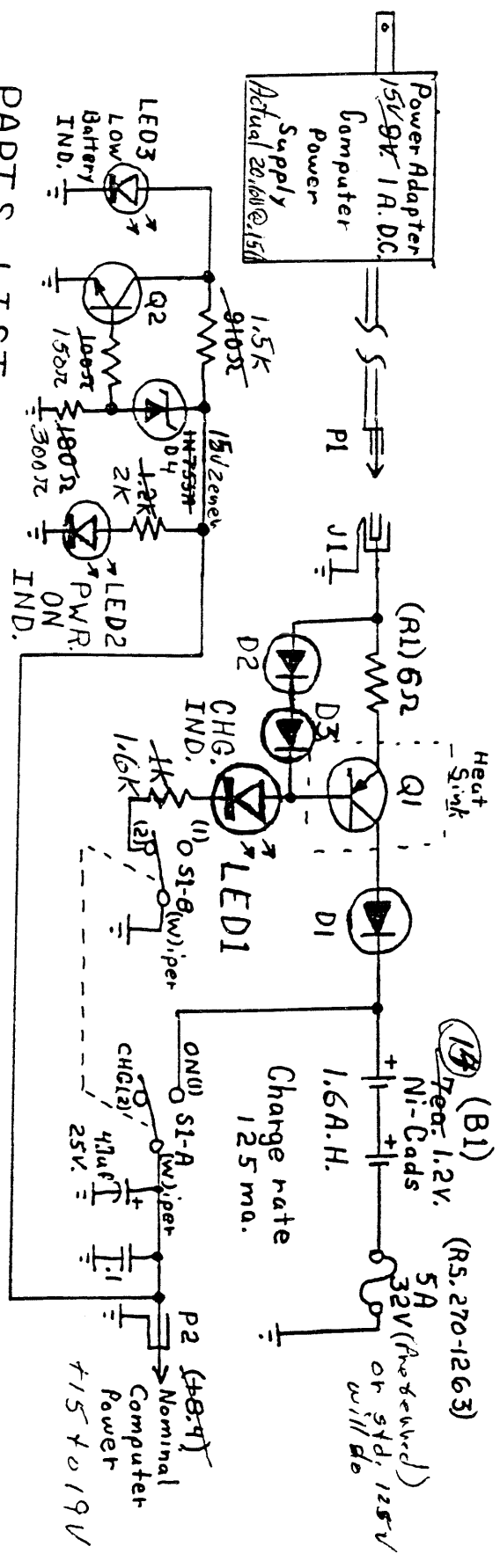

PARTS LIST:

- Q1 - 2N4919 (or equivalent) PNP, 40V, 3A, 30W
 - Q2 - 2N718 (or equiv.) 2N2222 etc. NPN Gen. Pur.
 - D1 - 1N4003 (or equiv.) 1Amp. @ 100V (R.S. 276-1103)
 - D2 & D3 - 1N4001 (or equiv.) 1Amp @ 50V (R.S. 276-1101)
 - D4 - 1N755A (or equiv.) 7.5V. Zener 1/2 watt (X2 in series)
 - LED1 - LED2 - - Jumbo. Red, T¹/₄ (R.S. 276-041)
 - LED3 - RED, T¹/₄, Blinking led (R.S. 276-036)
 - S1 - D.P.D.T. (Toggle or slide R.S. 275-403 or 691)
 - R1 - 6Ω 1/2 w (Parallel / ea. 10Ω & 12Ω 15Ω)
 - B1 - ¹/₄ each (1.6 A.H., 1.2V Ni-Cads (R.S. 23-190))
 - J1 - P2 (1/2 ea) Standard Plug & Jack (R.S. 42-2472)
- All resistors 1/2 w, all capacitors in uF
Sources: R.S. (Radio Shack), ECG (Local Elect. supplies)

5-13-92 R.A. JELEN

Please note changes in constant current charging circuit and also Note R1 @ 4Ω = 190mw, 5Ω = 150mw and 7Ω = 110mw and 8Ω = 90mw

#~~WSS~~ (2068 standard)
T/S-1000 1.6 A.H.

Ni-Cad. Power Supply features 8 HOURS run time with 30 minute reserve on Low Battery (LED 3), with Computer

only, ~~3 to 5 hrs.~~ T/S 1500 (w/all CMOS = 10+ hours)

TIMACHINE And The FDD System

by the late James Brezina

TIMACHINE may not work properly with the Zebra FDD system. Depending on which version of the FDD you have, either the keyboard will lock up as soon as TIMACHINE runs or everything will work correctly until you use FDD I/O commands. It should be noted that if you choose to modify TIMACHINE for the FDD as listed in this article, you will lose some friendliness and ease of use.

To determine which problem you have, do the following:- Load TIMACHINE from tape, answer 'N' to the backup copy prompt, the ENTER CAT *. If you are able to do this, then you have the FDD I/O problem. If you can't ENTER CAT *, you have the locked keyboard problem. To correct these problems, you should first transfer TIMACHINE to FDD:- MERGE the BASIC loader; change line 9997 to SAVE * ... (all SAVES!); SAVE TIMACHINE LINE 9997; then enter GOTO 9997. Answer 'Y' to the Backup Copy prompt. Now restart the system and MERGE TIMACHINE, then complete the correction with one of the following two procedures:

A. For a Locked Keyboard:

1. Line 40: change 26688 to 26694
2. Change all SAVES in line 8070 to SAVE * (DELAY CODE can be deleted).
3. Change all LOADS in line 9997 to LOAD

4. To use TIMACHINE, LOAD it from FDD and enter or load a BASIC program. Then invoke the TIMACHINE options as follows:

*C is invoked by typing RANDOMIZE USR 37476

*T will not work

*X is invoked by typing RANDOMIZE USER 37476 ERASE is invoked by typing RANDOMIZE USR 37536

*D is invoked by typing RANDOMIZE USR 37460

*E is invoked by typing RANDOMIZE USR 37468 NEW will no longer be trapped.

B. For the FDD I/O Problem:

1. Line 9997: remove the last command, GOTO 8000
2. Add lines 9998 and 9999 as follows:-
3. RESTORE 9999: FOR x=23780 TO 23792: READ y: POKE x, y: NEXT x: POKE 37402, 228: POKE 37403, 92: GOTO 8000
4. DATA 254, 122, 194, 224, 146, 237, 70, 241, 62, 230, 195, 48, 146
5. Enter: SAVE *"TSTIME" LINE 9997.
6. Note: Use the name by which your version calls the first part of TIMACHINE.
7. To use: *Z prior to any FDD I/O operation. RANDOMIZE USR 26688 after all FDD I/O operations. All other commands as per manual.

QL Video Output Circuit

by Richard Jelen

As I've gone to only using monitors (or TV's that have AUX. inputs) for my Timex computers. I bought an 8-pin DIN and following the service manual schematic I hooked it up and found that it is reverse, but no problem, as the mono composite video is the only one hooked up and doesn't have the proper signal strength anyway and the PAL output is not hooked up and in its place is +5V. I opted to build my own version Composite video output coming right off pin 9 of the MC1377P color chip. I use a GP transistor of fairly high freq. resp. and capacitor

coupled to standard phono plug output. This works great and gives a nice high signal with no distortion which works equally well with all my monitors and TV's AUX. inputs. This is exactly the same circuit I've designed for the 1000 and 1500.

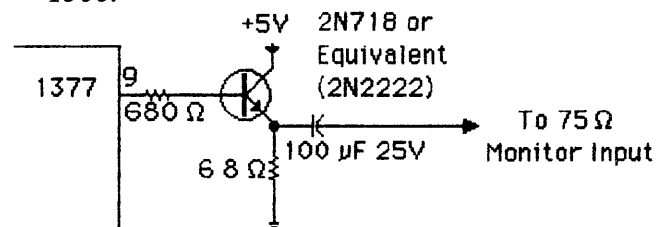

QL WOES

by Nazir A. Pashtoon

I Bill Lawson article (Nov/Dec 92 Toronto's SINC-LINK) mentioned a myriad of symptoms of his malfunctioning QL system. I hope he has resolved and sorted out these problems. The symptoms he mentioned;

Cursor disappears and machine locks up.

READ/WRITE FAILED

Double listing of Directories.

Use DELETE, get PROGRAM DOES NOT EXSITS.

Windows changing constantly.

Code? scrolls by.

MINERVA ROM is on board,

and a few more, apply to approximately a dozen QLs in my user group (CATUG) and my own. These problems invariably surface when a daughter-board with Minerva or QDOS EPROM is installed in the QL. To solve these problems, proceed as follows:

a) All the important integrated circuits in the QL are socketed. Socketed computers from LISA to the first shipments of ATARI ST and other computers were plagued by unreliable operation. The same is true of the QL. Many times the microdrive problem and unreliable video blanking is directly traceable to the ZX8302 and ZX8301 chips. Note that these two ICs are CMOS, and static-sensitive, touch a grounded metal object with your fingers before you touch the ICs. When you open your QL, it is advisable to spray the pins and sockets of these ICs, as well as the pin rows and sockets of other ICs with a "tuner cleaner", such as Radio Shack #64-3320, or equivalent. After spraying, use a flat-bit screw driver, or a butter knife to displace the chip slightly upwards from both ends. Spray again, and press the integrated circuits back in place. This cleaning should suffice for at least a year.

b) As mentioned earlier, many users who had fully functional machines, started having problems when they installed a small EPROM daughter-board inside the QL. After carefully studying the problem in about a dozen cases, I concluded that the problem is caused by hairline cracks in the copper traces of the daughter board. How are these hairline cracks caused?

After watching our members, and my own practice of how I would install the daughter-board on the QL motherboard, it became obvious that we ourselves were the culprits. To explain, normally we would first install the daughter-board by pressing on the corners of the board, and then press-in the EPROM. Both the procedure as well as the order in which the task is performed are wrong. Why?

The daughter-boards we were using, are flimsily constructed from very thin copper traces (to keep costs down, this is true of all peripheral boards, and the QL motherboard). As the figure shows, two sockets are installed side-by-side, with approximately 0.2" spacing, one socket that is used for the EPROM is an ordinary dual-leaf socket, and the other one is a machined socket. The pins of the machined socket protrude, and is fitted in the ROM socket on the QL motherboard. In order to install two sockets side-by-side one has to saw-off the socket stabilizing bridges (two or three). The consequence of this is that when you want to install an EPROM in the normal socket, it flexes the socket rows sideways so much that some times it is not possible to install the EPROM. This flexing causes the hairline cracks in the copper traces on the back of the daughter-board. Belatedly, one discovers that in order to install the EPROM, one has to hold the two rows of the socket pins of the normal socket vertically by one hand, and then fit the EPROM in the socket. We discover this after we have already caused damage to probably more than one trace.

The second mechanism causing the cracks, is the way we normally install the flimsily made daughter-board, by pushing on the corners of the board. This method of installation causes too much pressure on the corner pins of the machined socket, and possible hairline cracks. As such, the suggested procedure for installation is to :

➤ First install the EPROM on the daughter-board, while holding the normal socket in a vertical position with one hand, thus avoiding the flexing of the pins of the normal socket.

➤ Second, install the daughter-board on the motherboard by pressing on TOP of the EPROM, thus causing the pressure to be equally distributed on all the pins of the machined socket.

All these hassles could have been avoided if the boards were properly manufactured. For example, metalization both on top and bottom of the daughter-board would have helped. Most importantly, instead of using a low cost machined socket, the use of DIP socket carrier (say Digi-Key #ED6028, \$3.26) would have totally solved the problem. In this case you will have the benefit of machined pins, with pins flush on top, thus allowing the normal socket to straddle the socket carrier pins on top, without having to saw off the stabilizing plastic bridges.

The hairline cracks that I mentioned are hard to see even under a magnifying glass. Static testing by continuity measurements (using a VOM) could also be misleading. One can dynamically test by say, using a logic probe. One may even be tempted to cure the problem by putting solder globs on the affected traces. I recommend against it. The only sure method of solving the problem is, to do point-by-point wiring between the pins of the two sockets. This is much easier than it sounds. As shown in the

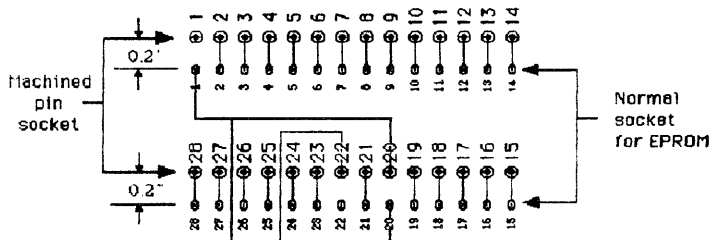

Back view of the daughter-board. The decoder IC is a 74HCT00 on my board.

figure, the two sockets are separated by a distance of 0.2", with all the respective pins connected by copper traces, except pins 1, 20, and 22. I use bare wrapping (28 gauge) wire. Make a tiny hook on one end of the wire, solder it to the pin, wrap the wire on the corresponding pin of the other socket for half a loop, solder and cut the wire with a razor blade or X-ACTO knife at the base of the pin. Do all the 25 pins shown in the diagram. This will, with high probability, solve your problem. In the worst case you may have to duplicate all the traces on the back of the daughter-board using wire-wrap wire. Do not use a soldering iron rated higher than 15 watts.

c) A third source of the cracks, is the protrusion of the daughter-board on top of the QL motherboard, and the pressure applied by the back of the keyboard. On the Samsung QLs, there is a screw on the back of the keyboard, which interferes with the top of the new EPROM that you install. One must remove this screw. Even the removal of this screw does not solve the problem, always. It is suggested that of the eight screws holding the keyboard and the base of the QL together, two screws, one in back and one in front, not to be installed. These are the screws which are left of center, roughly in alignment with the ROM sockets. It is worth mentioning, that depending on the height of the daughter-board, even the mother-board can be flexed by the pressure exerted through the daughter-board from the keyboard.

II. In the Mar/Apr 93 issue of Sink-Link, an article "Notes On QL Lock-Ups" by Hugh Howie, and I quote; "I know of one person who has four QLs and is only now starting to have some success with one of them. Power Surges?" Some QLs have exhibited this problem since its introduction into the market place. I have analyzed the problem, and I believe I have a low cost solution. I suggest that people facing this so called HEATING problem, send me \$2.00 cash, for the cost of a device, jiffy-bag, and mailing by return mail.

PS. After the above article was published, I received the Mark I version of Minerva 1.97. The daughter-board carrying a 1990 Copyright, is the best I have ever seen (in the QL market). It addresses all my objections. It has metalization on top and bottom with machine inserted metal eyelets connecting the top and bottom traces, with ground planes. Best yet, they have used only one machined socket for both the EPROM and the connection to the mother-board.

Nazir Pashtoon
940 Beau Dr. Apt. 204
DesPlaines, IL 60016-5876

The heating and cooling of the Printed Circuit Board (the turn ON and turn OFF of the computer) causes expansion and contraction of the copper foils (traces) that can cause intermittent loss of circuit continuity due to tarnish at the 'hairline cracks'.

Albed

Moving RAMTOP in ZX-81/TS -1000

Anthony J. Dresteen

This article will explain how to change the amount of memory you have available on the ZX-81 and TS-1000 computers. More importantly it will explain how to use 32K and 64K RAM packs efficiently.

The ZX-81 (I will only refer to the ZX-81 but it all applies the TS-1000 as well) computer can have up to 48k RAM added that is LOADable and saveable from Basic. Since the ZX-81 doesn't know how much memory is attached it checks to see how much memory is attached every time the power is turned on and the system self-boots. Unfortunately Sinclair never planned for more than 16K RAM of memory being added to the ZX-81 and initialization routine in the ROM does not check any memory above 32767 (the end of a 16K RAM pack). With a 64K pack attached you have memory locations up to 65535 but the ZX-81 will not know it and thinks that the memory is not there.

There are a number of RAM packs available (used and a few new) for the ZX-81. The most common sizes are 16K, 32K and 64K. Since the RAM area of the ZX-81 starts at 16384 and the highest memory location available is 65535 the most RAM that you can have is 65535- 16383 bytes or 49152 bytes on the ZX-81. As 1k of memory is 1024 bytes, 49152 is referred to as 48K. Some "64k" packs provide RAM UP TO the 64K location of 65535 and thus are called "64K" packs but actually have only 48K RAM while others provide 64K RAM from 0 to 65535 and allow you to switch in areas of RAM from 0 to 16383. Note that the ROM lies in the 0 to 8191 area and you will run into problems if you try to use that area. The area of 8192 to 16382 can have RAM but you can NOT put BASIC programs there so it's generally used for machine code routines and other accessory items. The Memotech 64K RAM pack is the unit I use and it will allow you to switch in areas below 16384 if you need that area. Some 32K packs will let you add an additional 16K pack to get a full

48K ram up to 65535 (the Memotech is one that will do this with no problems).

The ZX-81 has a number of system variables that keep track of where everything is in the computer. One system variable is called RAMTOP. It is located at 16388 and 16389. RAMTOP tells the computer how much memory is available. The computer takes the number stored in 16389, multiplies it by 256 and then adds it the number in 16388. This tells the computer the location of the first memory location that is not there. With a 16K pack attached you will get 128 if you enter PEEK 16389 and 0 for PEEK 16388. Thus $128 \times 256 + 0 = 32768$ for RAMTOP. By putting different numbers in 16388 and 16389 with the POKE command the computer will know how much memory you are using (well, not quite but more on this later).

There are three basic reasons that you would want to change RAMTOP:

1. To lower RAMTOP to provide room for machine code routines
2. that can not be overwritten by BASIC programs.
3. To lower RAMTOP to speed up save and load times.
4. To raise RAMTOP to make more memory space available to the computer.

It would appear that all you would have to do is to POKE in new numbers in 16388 and 16389 and RAMTOP is changed. Sadly this is not true. The computer will not fully recognize a RAMTOP change unless the command NEW is executed after the new value is placed in RAMTOP. The drawback is that NEW wipes out all of your Basic program and clears the variables area. The reason for this is that the machine stack and it's pointer (ERR_SP at 16386 & 16387) are still in the old area of memory, blocking expansion of the program and variables area (see page 128 of the Sinclair manual for a diagram). NEW will move these items to just below the new RAMTOP value

and the memory is opened up (or reduced as the case may be) for programming.

Method 1 to move RAMTOP.

The general format for method 1 is:

```
POKE 16388, L    (low value portion)
POKE 16389, H    (high value portion)
NEW
```

To find values of H & L first determine where you want RAMTOP to be. Let's assume that you are using a 32K RAMPACK and you want to use every bit of memory. 32K ends at 49151, so divide 49151 by 256. This gives 191.99609. Round the number down to the nearest whole number and you have the value of H or 191. Now multiply 191 by 256 and you get 48896. Subtract 48896 from 49151 and you will get 225 or L. Now you can enter the following:

```
POKE 16388, 255
POKE 16389, 191    (32K values)
NEW
```

If all this math bothers you, just enter RAND 49151 in the immediate mode. The values of SEED at 16434 & 16435 will have the correct values for L & H. The way that you could use this approach is:

```
RAND 49151
POKE 16388, PEEK 16434
POKE 16389, PEEK 16435
NEW
```

For a 64K pack the values of L & H are 255 and 255.

Method 2 to move RAMTOP .

In this method we will use a machine code routine that will do all the moving without using NEW. Thus we can execute a RAMTOP moving routine from within a program, without losing control of the computer (executing NEW from within a program wipes the program out and gives the K cursor).

You can use this program as a start-up program. For now let's assume that the RAMTOP routine is in line 10:

```
10 REM 000000000000000000
```

```
20 RAND USR 16514
30 LOAD ""
40 STOP
50 SAVE "64KRAMTOP"
60 RUN
```

If you save the program by ENTERing GOTO 50 in the immediate mode the program will self-start the next time you load it. It will load the next program on the tape automatically, and the proper value of RAMTOP will have been set (provided we insert the machine code routine in line 10 after the REM). If the second program is also self starting then for all practical purposes you will have LOADED only one program.

The machine code routine will do the following:

- a. Set new RAMTOP value
- b. Move the machine stack
- c. Set new ERR_SP value

LISTing 1 is the machine code routine. LISTing 2 is a byte-by-byte LISTing in decimal. Simply enter the first line of your program as 1 REM with at least 32 zeros following, then poke in each value starting with 16514. Then enter lines 20 to 60 as needed.

Rand USR 16514 tells the computer to go to memory location 16514 and start executing the machine code instructions until it comes to a number 201 which means return. Since the routine started from Basic it will return to Basic and execute the next basic line. A feature of the ZX-81 operating system is that the first line of Basic always starts at 16509. By making the first line a REM line with machine code instructions, we will always have the first machine code instruction at 16514.

To change the machine code routine to 32K, change 16516 to 191 and line 50 to:
SAVE "32KRAMTOP."

Method 3 to move RAMTOP using COMPUSA Disk Drive

When using the Compusa Floppy Disk Interface RAMTOP moves become very important. Many frustrating hours can pass trying to load a 16K Sinclair program that has a

lot of machine code on to disk. The Compusa DOS (version .5) copies the disk directory into RAM. To ensure that these DIRectories are never written over by Basic, on turning on the power the CDOS lowers RAMTOP by 1388 bytes and resets all pointers. Unfortunately the Compusa DOS (CDOS) doesn't check to see if you have more than 16K ram. If you are using 64K ram you must move RAMTOP as before, move the disk directory, and move the disk directory pointer. Then the CDOS will allow you to operate without getting lost.

The CDOS directory pointer is ALWAYS located at the byte pointed to by RAMTOP and the byte following. Wherever these two bytes point to the CDOS will look for the disk directory. If the directory is not there the system will crash and you will have to power down and then start over again. In a 16K system the pointer & RAMTOP are as follows:

```
16388 147 RAMTOP points to 31379
16389 122
31379 149 CDOS pointer points to 31381
31380 122
31381 CDOS directory starts here
```

I use the following locations for RAMTOP when using 64K and 32K packs:

```
For 64K: 16388, 147 RAMTOP at 64147
16389, 250
64147, 149 DIRectory at 64149
64148, 250
```

```
For 32K: 16388, 147 RAMTOP at 47763
16389, 186
47763, 149 DIRectory at 47765
47764, 186
```

These locations put the DIRectories at the top of memory and free up the most RAM for programming. While you could poke in the four new values, execute NEW, and then do a GET DIRectory CDOS command, the following program will do it in machine code and you never give up control of the computer. LISTing 3 is the machine code program. LISTing 4 is a decimal byte-by-byte breakdown that you can poke into a REM statement that has 53 zeros after it. LISTing 5 is the Basic LISTing. This program is for 64K. If you have

a 32K pack use LISTing 6 & 7 for the correct values and change line 20 in the Basic program to read: IF PEEK 16389<186 then GOTO 70.

LISTing 5 needs some explanation. Start up the system and ensure that the CDOS is at the 16K setting. Load the RAMTOP routine. Enter in the immediate mode: GOTO 50. Line 50 makes the program a self-starting CDOS program. Line 60 MUST be a GOTO, do not change to RUN. For some unknown reason using RUN in a self-starting CDOS program sends the computer off into never- return land. GOTO 10 keeps everything in control. Line 30 looks for a menu program on the disk. If you don't have a menu then the CDOS will give you an error message and stop.

You should now have a good understanding on how the ZX-81 sets RAMTOP and how you can change it to suite your needs. All of the programs are tested and do work. Good luck and happy computing!

Anthony J. Oresteen
452 Orion Rd
Batavia, IL 60510
708/ 879-5608

ZX-81 POKES & Calls

Use at your own risk

RAND USER 0

clears program & restarts.

RAND USER 681

in FAST mode, prevents report code from display.

RAND USER 757

in FAST mode saves a program without a name.

RAND USER 836

in FAST mode, will load a program and STOP it even if it is self starting. Gives a C error code but disregard. Hit LIST and there is the program. Some MC programs initialize from the PRINT buffer and you may not get a LISTing. I have seen only one program that did this [HOT Z-1]. Most start with a RAND USER 16514.

RAND USER 930

equivalent to BREAK.

RAND USER963

clears program area & variables (NEW)

RAND USER 2955
equivalent to “,” in PRINT statement.
RAND USER 3086
scrolls up one line.
RAND USER 3292
equivalent to STOP.
RAND USER 3875
equivalent to FAST.
RAND USER 3883
equivalent to SLOW.
POKE 16418, 0
makes a 24 line display (don't scroll or INPUT
= CRASH)
POKE 16441, 20

gives a 34 column display (careful, can cause
CRASHes)
POKE 16509, N
N=40 to 63. Makes editing hard; line # have
letters. N=99 prevents program from running or
LISTING, POKE to 0 to restore operation.
POKE 16510, 0
makes first line number 0, can't be edited. Use
for Copyright notice. To hide LISTing use the
following:- ENTER “1 REM aa” then POKE
16514, 118 and POKE 16515, 118; LISTing is
gone.

Anthony T. Oresteen

DID YOU TRY THIS?

by Abed Kahale

```

5 OVER 1: BORDER 0: PAPER 0:
INK 2: CLS
10 GO SUB 100
15 LET A=2
20 LET I=INT (RAND*7)+1: IF I=A
THEN GO TO 20
25 INK I: LET A=I: GO SUB 200:
GO SUB 100: GO SUB 100: GO SUB
200: GO TO 20
100 FOR X=0 TO 255
105 PLOT X,0: DRAW 255-X,175: P
LOT 255-X,175: DRAW X-255,-175
110 NEXT X
115 RETURN
200 FOR X=0 TO 255
205 PLOT X,175: DRAW 255-X,-175
PLOT 255-X,0: DRAW X-255,175
210 NEXT X
215 RETURN
9000 SAVE "MOIRE" LINE 0

```

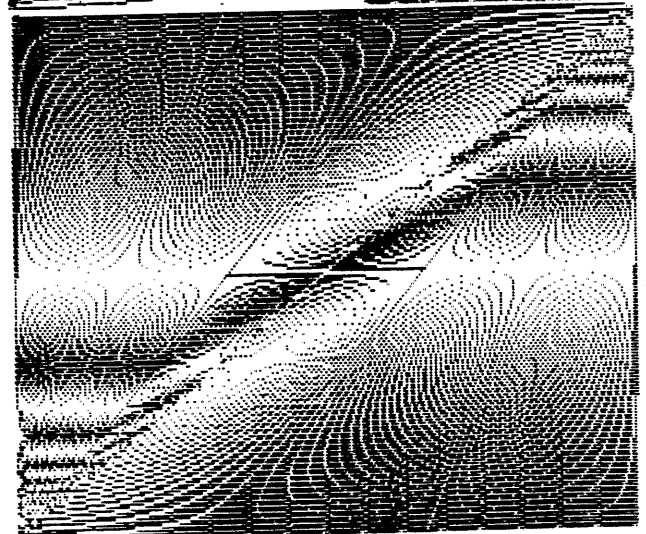
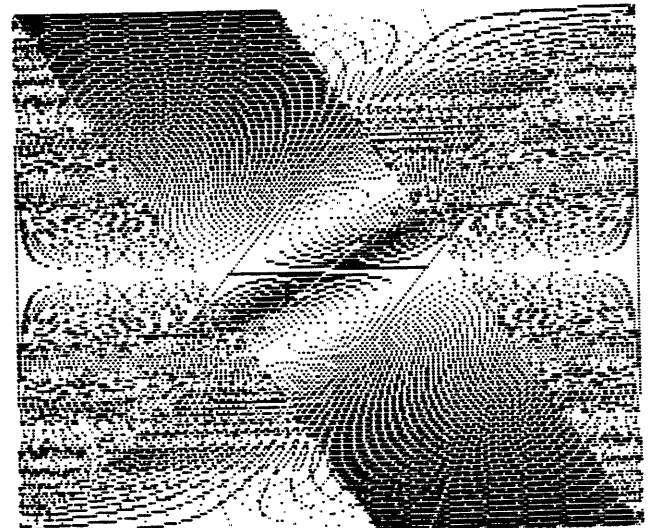
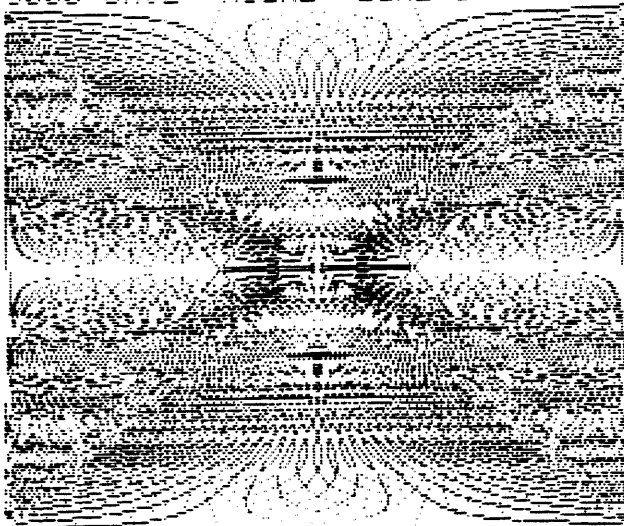

LISTING 1

4082~11FFFF LD DE,FFFF
4085 2A0440 LD HL,(RMTP)
4088 2B DEC HL
4089 ED530440 LD (RMTP),DE
408D 014000 LD BC,0040
4090 EDB8 LDDR
4092 EB EX DE,HL
4093 AF XOR A
4094 ED52 SBC HL,DE
4096 54 LD D,H
4097 5D LD E,L
4098 39 ADD HL,SP
4099 F9 LD SP,HL
409A 2A0240 LD HL,(ERSP)
409D 19 ADD HL,DE
409E 220240 LD (ERSP),HL
40A1 C9 RET

LISTING 4

4082~AF 175 16514 J
4083 ED 237 16515 GOSUB
4084 73 115 16516
4085 78 HZET 123 16517
4086 40 54 16518 RND
4087 ED 237 16519 GOSUB
4088 5B 91 16520
4089 7B HZET 123 16521
408A 40 64 16522 RND
408B 21 33 16523 5
408C FF 255 16524 COPY
408D 7F 127 16525
408E ED 237 16526 GOSUB
408F 52 82 16527
4090 44 68 16528
4091 4D 77 16529
4092 21 33 16530 5
4093 FF 255 16531 COPY
4094 7F 127 16532
4095 11 17 16533)
4096 FF 255 16534 COPY
4097 FF 255 16535 COPY
4098 ED 237 16536 GOSUB
4099 B8 184 16537 s
409A 11 17 16538)
409B 00 0 16539
409C 00 128 16540
409D 2A 42 16541 E
409E 7B HZET 123 16542
409F 40 64 16543 RND
40A0 19 25 16544 ;
40A1 F9 249 16545 RAND
40A2 2A 42 16546 E
40A3 02 ERSP 2 16547
40A4 40 64 16548 RND
40A5 19 25 16549 ;
40A6 22 34 16550 6
40A7 02 ERSP 2 16551
40A8 40 64 16552 RND
40A9 2A 42 16553 E
40AA 04 RMTMP 4 16554
40AB 40 64 16555 RND
40AC 19 25 16556 ;
40AD 22 34 16557 6
40AE 04 RMTMP 4 16558
40AF 40 64 16559 RND
40B0 21 33 16560 5
40B1 95 149 16561 @
40B2 FA 250 16562 IF
40B3 22 34 16563 6
40B4 93 147 16564 -
40B5 FA 250 16565 IF
40B6 C9 201 16566 TAN

LISTING 6

4882~AF 175 16514 J
4883 ED 237 16515 GOSUB
4884 73 115 16516
4885 78 HZET 123 16517
4886 40 64 16518 RND
4887 ED 237 16519 GOSUB
4888 5B 91 16520
4889 7B HZET 123 16521
488A 40 64 16522 RND
488B 21 33 16523 5
488C FF 255 16524 COPY
488D 7F 127 16525
488E ED 237 16526 GOSUB
488F 52 82 16527
4890 44 68 16528
4891 4D 77 16529
4892 21 33 16530 5
4893 FF 255 16531 COPY
4894 7F 127 16532
4895 11 17 16533)
4896 FF 255 16534 COPY
4897 BF 191 16535 z
4898 ED 237 16536 GOSUB
4899 B8 184 16537 s
489A 11 17 16538)
489B 00 0 16539
489C 40 64 16540 RND
489D 2A 42 16541 E
489E 7B HZET 123 16542
489F 40 64 16543 RND
48A0 19 25 16544 ;
48A1 F9 249 16545 RAND
48A2 2A 42 16546 E
48A3 02 ERSP 2 16547
48A4 40 64 16548 RND
48A5 19 25 16549 ;
48A6 22 34 16550 6
48A7 02 ERSP 2 16551
48A8 40 64 16552 RND
48A9 2A 42 16553 E
48AA 04 RMTMP 4 16554
48AB 40 64 16555 RND
48AC 19 25 16556 ;
48AD 22 34 16557 6
48AE 04 RMTMP 4 16558
48AF 40 64 16559 RND
48B0 21 33 16560 5
48B1 95 149 16561 @
48B2 BA 186 16562 u
48B3 22 34 16563 6
48B4 93 147 16564 -
48B5 BA 186 16565 u
48B6 C9 201 16566 TAN

LISTING 7

4082~11FFFF LD DE,BFFF
4085 2A0440 LD HL,(RMTP)
4088 2B DEC HL
4089 ED530440 LD (RMTP),DE
408D 014000 LD BC,0040
4090 EDB8 LDDR
4092 EB EX DE,HL
4093 AF XOR A
4094 ED52 SBC HL,DE
4096 54 LD D,H
4097 5D LD E,L
4098 39 ADD HL,SP
4099 F9 LD SP,HL
409A 2A0240 LD HL,(ERSP)
409D 19 ADD HL,DE
409E 220240 LD (ERSP),HL
40A1 C9 RET

LISTING 2

4082~11 17 16514)
4083 FF 255 16515 COPY
4084 FF 255 16516 COPY
4085 2A 42 16517 E
4086 04 RMTMP 4 16518
4087 40 64 16519 RND
4088 2B 43 16520 F
4089 ED 237 16521 GOSUB
408A 53 83 16522
408B 04 RMTMP 4 16523
408C 40 64 16524 RND
408D 01 FLGS 1 16525
408E 40 64 16526 RND
408F 00 0 16527
4090 ED 237 16528 GOSUB
4091 B8 184 16529 s
4092 EB 235 16530 FOR
4093 AF 175 16531 J
4094 ED 237 16532 GOSUB
4095 52 82 16533
4096 54 84 16534
4097 5D 93 16535
4098 39 57 16536 T
4099 F9 249 16537 RAND
409A 2A 42 16538 E
409B 02 ERSP 2 16539
409C 40 64 16540 RND
409D 19 25 16541 ;
409E 22 34 16542 6
409F 02 ERSP 2 16543
40A0 40 64 16544 RND
40A1 C9 201 16545 TAN

LISTING 10

4082~11 17 16514)
4083 FF 255 16515 COPY
4084 BF 191 16516 z
4085 2A 42 16517 E
4086 04 RMTMP 4 16518
4087 40 64 16519 RND
4088 2B 43 16520 F
4089 ED 237 16521 GOSUB
408A 53 83 16522
408B 04 RMTMP 4 16523
408D 01 FLGS 1 16525
408E 40 64 16526 RND
408F 00 0 16527
4090 ED 237 16528 GOSUB
4091 B8 184 16529 s
4092 EB 235 16530 FOR
4093 AF 175 16531 J
4094 ED 237 16532 GOSUB
4095 52 82 16533
4096 54 84 16534
4097 5D 93 16535
4098 39 57 16536 T
4099 F9 249 16537 RAND
409A 2A 42 16538 E
409B 02 ERSP 2 16539
409C 40 64 16540 RND
409D 19 25 16541 ;
409E 22 34 16542 6
409F 02 ERSP 2 16543
40A0 40 64 16544 RND
40A1 C9 201 16545 TAN

LISTING 2A

0~REM) COPY COPY ERNDF GO:
B ?RND?RND GOSUB s FOR J GOSU
????? RAND ERND;6RNDTAN
ANTHONY J ORESTEEN 64K RAM B
10 RAND USR 16514
20 IF PEEK 16389<255 THEN G
70
30 LOAD ""
40 STOP
50 SAVE "64KRAM"
60 GOTO 10
70 PRINT "RAMTOP ERROR. PLE
RE-START."

LISTING 5

0~REM J GOSUB ??RND GOSUB ??
D5 COPY K GOSUB ???5 COPY K) CC
COPY GOSUB s) E?RND; RAND EF
D;6RND?RND;6RND50 IF 6_ IF T
N A ORESTEEN 64K CDOS BOOT
10 RAND USR 16514
20 IF PEEK 16389<250 THEN GOT
70
30 LOAD "A:MENU.P"
40 STOP
50 SAVE "A:64KDOS,S.P"
60 GOTO 10
70 PRINT "RAMTOP ERROR. PLEASE
RE-START."

LISTING 8

0~REM J GOSUB ??RND GOSUB ??R
D5 COPY K GOSUB ???5 COPY K) ?P
z GOSUB s) RND?RND; RAND ERN
;6RND?RND;6RND50u6_uTAN
A ORESTEEN 32K CDOS BOOT
10 RAND USR 16514
20 IF PEEK 16389<186 THEN GOTO
70
30 LOAD "A:MENU.P"
40 STOP
50 SAVE "A:32KDOS,S.P"
60 GOTO 10
70 PRINT "RAMTOP ERROR. PLEASE
RE-START."

LISTING 3

4082~AF XOR A
4083 ED737B40 LD (HZET),SP
4087 ED5B7B40 LD DE,(HZET)
408B 21FF7F LD HL,7FFF
408E ED52 SBC HL,DE
4090 44 LD B,H
4091 4D LD C,L
4092 21FF7F LD HL,7FFF
4095 11FFFF LD DE,FFFF
4098 EDB8 LDDR
409A 110000 LD DE,0000
409D 2A7B40 LD HL,(HZET)
40A0 19 ADD HL,DE
40A1 F9 LD SP,HL
40A2 2A0240 LD HL,(ERSP)
40A5 19 ADD HL,DE
40A6 220240 LD (ERSP),HL
40A9 2A0440 LD HL,(RMTP)
40AC 19 ADD HL,DE
40AD 220440 LD (RMTP),HL
40B0 2195FA LD HL,FA95
40B3 2293FA LD (FA93),HL
40B6 C9 RET

LISTING 6

4082 AF ~XOR A
4083 ED737B40 LD (HZET),SP
4087 ED5B7B40 LD DE,(HZET)
408B 21FF7F LD HL,7FFF
408E ED52 SBC HL,DE
4090 44 LD B,H
4091 4D LD C,L
4092 21FF7F LD HL,7FFF
4095 11FFBF LD DE,BFFF
4098 EDB8 LDDR
409A 110040 LD DE,ERNR
409D 2A7B40 LD HL,(HZET)
40A0 19 ADD HL,DE
40A1 F9 LD SP,HL
40A2 2A0240 LD HL,(ERSP)
40A5 19 ADD HL,DE
40A6 220240 LD (ERSP),HL
40A9 2A0440 LD HL,(RMTP)
40AC 19 ADD HL,DE
40AD 220440 LD (RMTP),HL
40B0 2195BA LD HL,BA95
40B3 2293BA LD (BA93),HL
40B6 C9 RET



FRUSTRATED PC USERS FLOOD HELP LINES

by Joan Kealy

Austin, TX. newspaper — March 4, 1994

Austin - The exasperated help-line caller said she couldn't get her new Dell computer to turn on. Jay Albinger, a Dell Computer Corp. technician, made sure the computer was plugged in and then asked the woman what happened when she pushed the power button.

"I've pushed and pushed on this foot pedal and nothing happens," the woman replied.

"Foot pedal?" the technician asked.

"Yes," the woman said, "this little white foot pedal with the ON switch."

The "foot pedal," it turned out, was the computer's MOUSE, a hand-operated device that helps to control the computer's operations.

Personal-computer makers are discovering that it's still a low-tech world out there. While they are finally having great success selling PC's to households, they now have to deal with people to whom monitors and disk drives are as foreign as another language.

"It is rather mystifying to get this nice, beautiful machine and not know anything about it," said Ed Shuler, a technician who helps field consumer calls at Dell's headquarters.

"It's going into unfamiliar territory," said Gus Koliias, vice president of consumer service and training for Compaq Computer Corp.

Only two years ago, most calls to PC help lines came from techies needing help on complex problems. But now, with computer sales to homes exploding as new "multimedia" functions gain mass appeal. PC makers say that as many as 70 percent of their calls come from rank novices.

The questions are often so basic that they could have been answered by opening the manual that comes with every machine. One woman called Dell's toll-free line to ask how to install batteries in her laptop. When told that the directions were on the first page of the manual, said Steve Smith, Dell's director of technical support, the woman replied angrily, "I just paid \$2,000. for this damn thing, and I'm not going to read a book."

Indeed, it seems that these buyers rarely refer to a manual when a phone is at hand. "If there is a book and phone and they're side by side, the phone wins time after time," said Craig McQuilkin, manager of service marketing for AST Research Inc. in Irvine, CA. "It's a phenomenon of people wanting to talk to people."

And do they ever. Compaq's help center in Houston is inundated with some 8,000 consumer calls a day, with inquiries like this one related by technician John Wolf.

"A frustrated customer called who said her brand New Con-

tura would not work. She said she had unpacked the unit, plugged it in, opened it up and sat there for 20 minutes waiting for something to happen. When asked what happened when she pressed the switch, she asked, "What power switch?"

Seemingly simple computer features baffle some users. So many people have called to ask where the "any" key is when "Press Any Key" flashes on the screen that Compaq is considering changing the command to "Press Return Key."

0/0



COPY1	Checks & copies 6 blocks at a time, makes up to 4 copies.
COPY3	✓ Checks & copies > 6 blocks at a time, exact memory length., up to 4 copies.
COPY2	FORMATs then copies, copies 5 blocks at a time. (Customize before use)
COPY4	✓ FORMATs then copies, exact memory length. (Customize before use)
MOVE	✓ Copies one or all selected files in one go.
FORMAT	FORMATs and maps-out bad blocks. (Customize before use)
FASTF	✓ Fast FORMATs previously formatted disks. (Customize before use)
FRESHEN	Reformats without losing files on bad disk.
FFRESH	Freshens without reformat.
MAPOUT	✓ Maps-out bad blocks.
TMAPED	Manual block map-out.
RECCAT	Rebuilds glitched CATalog.
RECOVR	✓ Recovers erased files if not overwritten.
RECBAD	✓ Recovers blocks from bad disk and copies to another disk.
HEAD	✓ Changes head speed.
TRKSID	✓ Changes and reformats tracks and sides, good for dissimilar disks.
FTRKSD	✓ Fast change of tracks and sides on already formatted disk.
CLENUP	Clears and reformats unused blocks and invalid files.
FCLEAN	Clears unused blocks and invalid files.
ERASE	✓ Erases one or all selected files in one go.
INIT	✓ Erases all files.
CHKDSK	Disk information.
FANALY	File analyzer.
BANAL	Block analyzer.
BEDIT	Block editor.
THIEF	Copies disk name to another.
SORT	✓ Sorts files in alphabetical order.
RENAME	Renames one or all selected files.
COLNAM	✓ Adds color to disk name.
DSKNAM	Edits disk name, not for colored names.
BOOT	AUTOSTART
MINIBT	Boot.

Customization

Edit LET A\$ = " _ " add

L for LarKen

O for Oliger

A for AERCO

R for RAMEX

Revised 3/94

PD Library SSDD or DSDD LKDOS 5.25" disks are available for \$3.50 each PP. (We do not wish to compete with our dealers). From:

A. KAHALE

335 W NEWPORT RD

HOFFMAN ESTATES IL 60195-3106

WHY THE OLIGER DISK I/F WITH JLO SAFE IS THE BEST AVAILABLE FOR YOUR TS-2068

It is the only system that does not require RAND USR calls.

JLO SAFE V2 has the easiest syntax structure. The SAFE commands are easier to learn than *any* other system. Just enter the disk commands exactly like you would for tape cassette but put the / character directly after the SAVE, LOAD, etc. to tell the system to use the disk system instead of tape!

Most of the commands require fewer keystrokes to enter and use less memory within 2068 or Spectrum BASIC.

The Oliger Disk I/F is the only one that does not use the Dock bank memory nor the cartridge port. It will work with any AROS cartridge.

Is as fast or faster than any other DOS for the 2068.

CMOS logic chips and simple design allow the Oliger disk I/F to consume less power from the 2068, and causes less Loading on the Z80 outputs.

The modular design of the Oliger Disk I/F hardware allows easier trouble shooting if they should ever fail. Service by John Oliger Co. is available if needed.

Is the only one for the 2068 that features sockets on *every* IC for ease of repair. Saving a few cents by soldering ICs is *never* done by John Oliger Co.

Is the only 2068 disk I/F available as either fully assembled & tested, as kits or as bare boards with full instructions on assembly and testing. Repair of non-functioning kits is also available.

The John Oliger Co. has been serving the Timex/Sinclair enthusiast for over 10 years, and will be around for further support in the future. You will not have an orphan Disk I/F for your orphan Sinclair!

Is the only DOS available that will expand with the future. If and when drives become available that can handle more than 84 or 85 tracks JLO SAFE will be ready to handle them by using a simple BASIC command. SAFE allows up to 255 tracks per side, if the drives ever do!

Can speed up your BASIC programs via a fast integer FOR/NEXT loop structure that will beat a QL or Commodore 128 BASIC machine!

Has the most functions available via the NMI save button. STATE SAVES, screen SAVES, screen COPY, quit to BASIC, PAUSE, and RESET are available.

Allows use of different drive types and sizes at the same time. The MOVE /"filename" command will transfer files between dissimilar drives with ease.

Actual Example of Normal CATalog

JLO SAFE V2.65 1992 J. OLIGER

DISK NAME: INVOICE MASTER
 FORMATTED @85 TRACKS, 2 SIDE(S)
 CAPACITY: 169 CYLS/845K BYTES
 FREE: 125 CYLS/625K BYTES

FILENAME	TYPE	CYLS	SIZE	START
INVOICE WR	BASIC	3	13146	1
invoice wr	BASIC	3	13140	1
VERIFY	STATE	10	49664	
ERASED?	STATE	10	49664	
spec code	BYTES	4	16384	32768
SPEC CODE	BYTES	4	16384	32768
BAD CODE	BYTES	4	16384	32768
SPEC CODE3	BYTES	4	16384	32768
VERIFYBAS	BASIC	1	436	
BASIC	BASIC	1	67	
TOTAL FILES: 10				

OLIGER DISK I/F W/JLO SAFE SPECIFICATIONS

Number of drives supported: 1, 2, 3, or 4
 Number of sides per drive: 1 or 2
 Number of tracks per side: 10-255. (Most drives only 40 or 80)
 DOS does not use RAM or memory space. SAFE is contained on an EPROM in another bank.
 No booting of DOS required.
 SAVE/LOAD transfer speed: 250K bits per second (32K bytes per second) Snapshot SAVE.
 True LOAD speed : 48K bytes in approx. 4 seconds
 True SAVE speed: 48K bytes in approx. 7 seconds (auto Verify)
 Formatted capacity (per disk):-
 40 track, double-sided = 395K 40 track, single-sided = 195K
 80 track, double-sided = 795K 83 track, double-sided = 825K
 Maximum number of files per disk: 177
 Disk allocation cluster size: 5K Always Double Density.
 Compatible with 2068 Spectrum mode, 0S64 cartridge and AROS cartridges

Other functions are supported by snapshot SAVE button. Also supports a SCREEN\$ SAVE to disk, a screen copy to the Oliger Printer Port or return to BASIC.

Large serial printer support built in. Supports some combinations of the AERCO printer I/F used with some printers.

All types of cassette files are supported in all the possible combinations along with new variables only SAVE/LOAD and total state (everything) SAVE/LOAD.

SAVE/LOAD commands are EXACTLY as is required for the cassette commands but with the / character immediately after the SAVE or LOAD keyword. e.g.: SAVE /"Program" LINE 1 or LOAD /"screen" SCREEN\$.

WE PAY POSTAGE (First Class) on all orders to continental USA or Canada. Other foreign countries add 10% for post/packing. Indiana residents add 5% sales tax. Prepaid orders only, no credit cards. Prices subject to change without notice. NOTE: All of the boards as well as all future John Oliger Co. boards are designed with edge trace "fingers" to fit the 2068 Expansion Board. The ONLY exception to this is the 2068 User Cartridge which plugs into the cartridge slot on your computer and the Vpp power supply which is a free standing board. All my products include a 10 day money back satisfaction guarantee, if returned UNSOLDERED and in same condition received. Assembled units are Guaranteed to work as promised or will be repaired free for 30 days from shipment date if faulty in material or workmanship.

The John Oliger Co.

11601 Whidbey Dr.
 Cumberland, IN 46229

transcribed by A. Kahale

RMG Enterprises

14784 South Quail Grove Cir.
Oregon City OR 97045

Items That Would Like To Find A New Home! Read This!

- | | |
|--|---|
| 1> TS 1000 IN LARGE BURROUGHS FULL KEYBOARD-----\$ 30.00 | 1> SONY TC-66 TAPE RECORDER (1 BUTTON MISSING)-----\$ 12.50 |
| 2> TS 1016 RAM PAKS-----BOTH!---(1000)-----\$ 8.00 | 1> BOOK - 51 GAMES FOR THE TS1000-----\$ 3.50 |
| 1> MEMOTECH 32K MEMOPAK RAM PAK-(1000)-----\$ 25.00 | 2> BOOK - 10 STARTER PROGRAMS FROM FAMILY COMPUTING-\$4.50 EA |
| 1> SOUNDWAVE TAPE RECORDER-----\$ 12.50 | 1> BOOK - BEST OF FAMILY COMPUTING PROGRAMS-----\$4.50 |

Super buy! All of the above for only \$95 postpaid!
For above item(s) please use reference # HDU0691

- 1 > QL computer in large case w/full travel KB----\$ 65.00pp

For Above Item(S) Please Use Reference # EFU0690

- | | |
|--|---|
| 1> FRANKLIN PC 8000 XT COMPATIBLE/512K RAM/2 360K DRIVES/NO
SLOT CLOCK INSTALLED/1 EXTRA SLOT DOS 3.2/GWBASIC AND
MANUALS-----\$150.00PP | 1> BOOK PACKAGE-(ALL OR NONE):HOW TO USE THE T/S COMPUTER/
THE TS 2068 EXPLORED/TS1500/1000 MC PROGRAMMING AND
INTERFACING/MC AND BETTER BASIC-----\$ 25.00PP |
| 1> 8-BIT RLL HD CONTROLLER-----\$ 25.00PP | 1> 2068 S/W PACKAGE-(ALL OR NONE):STATES-CAPS/PENETRATOR/
VUFIL/ANDROIDS/SPELLING II/BLIND ALLEY/BUDGETEER/+20 |
| 1> TANDY/IBM JOYSTICK-----\$ 15.00PP | MORE TITLES-(MANY NON TS)-----\$ 30.00PP |
| 1> LOTUS WORKS-NEW-COMLETE-----\$ 50.00PP | 1> TS1000 S/W PACKAGE-(ALL OR NONE): 4 TITLES ----\$ 5.00PP |
| 1> LOTUS 1 - 2 - 3 REL 2.2 NEW - IN SHRINK-----\$ 50.00PP | |
| 1> RGB (CGA) MONITOR W/CGA CARD 8 BIT -----\$ 90.00PP | |

For Above Item(S) Please Use Reference # GBU0990

Just In! Great Buy On 286!!!

- 1 Only - Tandon 286/12 motherboard in case with PS---\$115.00+pp

1 Meg RAM exp. To 5 Megs/ser-par ports/manuals no drives no keyboard no monitor or color card. == Or==

We will install a 1.2M-5.25" or 1.44M-3.5" floppy/101 KB CGA card and include 14" CGA monitor W/DOS

4.01 and manuals

All for only \$450.00 pp

For Above Item(S) Please Use Reference # ANOU0392

Unless otherwise noted all items include shipping!

CNSN-2 Last Updated: February 11, 1994

More Items That Would Like To Find A New Home! Read This!

- | | |
|---|--|
| 1> PC TO QL MONITOR ADAPTOR (USE QL MONITOR ON PC)-\$ 45.00
Like your QL Vision Monitor? Want to use it on your PC?
This adaptor w/power supply will allow you to do that with
any CGA output. | 1> TS 2068 IN WOODEN CASE W/LARGE KB/RESET/MORE-\$ 85.00PP |
| | 1> DMP-430 15" DOT MATRIX PRINTER (GOOD SHAPE) -\$110.00PP |

For above item(s) please use reference # DSU1190

- | | |
|--|--|
| 1> BSR 1200 BAUD EXTERNAL MODEM - LIKE NEW!-----\$ 40.00 | 1> COMPOSITE MONOCHROME 12" MONITOR-----\$ 45.00 |
| 1> TANDY COCO PACKAGE -----\$ 40.00 | |

For above item(s) please use reference # REGU0591

- | | |
|--|---|
| 1> TS 1000 IN KRADLE KEYBOARD W/ADDED RAM-----\$100.00
A REAL COLLECTOR'S ITEM! | 1> SOFTWARE FARMS HI-REZ SOFTWARE PAK--3 PIECES-----\$ 20.00
ALL 3 TITLES FOR THE 1000 |
| 1> MELBOURNE HOUSE SOFTWARE PAK-8 PIECES-----\$ 25.00 | 1> TIMEX SOFTWARE PAK--3 PIECES-----\$ 10.00 |
| 1> SOFTSYNC SOFTWARE PAK--9 PIECES-----\$ 25.00 | 1> MAGAZINE/BOOK PAK--3 BOOKS/21 MAGS-----\$ 25.00 |

For above items please use reference # FRSU0792

- | | |
|--|---|
| 1> MIRACLE QL PRINTER INTERFACE ----- \$ 40.00 | 2> AERCO FD-68 DISK INTERFACE W/256K RAM ----- \$105.00EA |
| 1> QL TECHNICAL GUIDE ----- \$ 10.00 | 1> COLECO POWER SUPPLY FOR USE WITH FD-68 ----- \$ 5.00 |
| 1> RITEMAN 9 PIN DOT MATRIX PRINTER ----- \$115.00 | INCLUDES: TRACTOR/ROLL FEED W/8 RIBBONS GRAPHICS COMPATIBLE |

For above items please use reference # RDSU0393

- | | |
|--|--|
| 1> TIMEX SINCLAIR 1000/ZX81 USERS MANUAL ----- \$ 2.50 | 1> MASTERING YOUR TS1000 PERSONAL COMPUTER ----- \$ 2.50 |
| 1> THE TIMEX PERSONAL COMPUTER MADE SIMPLE ----- \$ 2.50 | |

COLLECTOR'S ITEMS

Lipinski's software buyer's guide to ts products and sevice's in loose leaf binder ----- \$ 10.00+3sh

For above items use reference # HCU0793

CNSN-3 last updated: December 4, 1993

- | | |
|---|---|
| -(1) TS1000 with Filesixty rubber keyboard overlay, excellent condition. \$20 (Add \$5 for 1000 ma power supply). | switches, AC & CD fuse holders, reset switch, video inverter, AC outlets for power pak/TV/cassette, MOV spike protection. DC voltmeter & ammeter. Paint is scratched some, but good for peripheral experimentation. \$50 plus \$7 shipping. |
| -(1) MagicBridge 16K rampak (Great Britain). Siliconed rear cover removed, can easily be replaced. Like new \$4 | |
| -(1) E-Z Key Keyboard mounted in 9"x14" E-Z Key enclosure. TS1000 mounted inside. Added features: AC & DC power | |

For above items please use reference # VVU0491

- | | |
|---|---|
| 4> TS 1000 S/W:PROG. TOOLKIT/GRAPHICS KIT/PAC-RABBIT
WMJ SUPERTAPE -----ALL-----\$ 12.00 | 1> A&J PRINTER DRIVER SOFTWARE FOR 2068 AND A&J ---\$ 5.00
2> TS 1000 COMPUTERS IN ORIGINAL BOXES -NEVER USED \$ 28.00EA |
|---|---|

For above item(s) please use reference # FHU0291

- | | |
|--|--|
| 1> MIRACLE CENTRONICS I/F ----- \$ 40.00PP | 1> DUAL 5.25 DRIVES W/CASE/CABLE/PS ----- \$195M00PP |
|--|--|

For above item(s) please use reference # SAU0291

Another Great Package Buy!

Here is your chance to get a Sinclair QL, in great shape, with power supply, manual and original software, 8 blank MDV carts and a box that holds 12 cartridges. You will also get a NAP 12" amber composite monitor and all cables needed to hook it up. To round out the package, there are 3 books and several issues of QL magazines to go along.

ALL OF THIS FOR ONLY \$150!!

Please add \$15.00 for shipping within the 48 contiguous states.

Don't wait! This one will sell fast! A great starter or back up package for someone.

Use reference # JCU0893

NOTE: All of the above include shipping unless noted to add more. Please allow 3-6 weeks delivery on these items. Owner will be shipping direct to the buyer.

CNSN-5 Last Updated: February 11, 1994

Here Is A Real Bonanza Of Ts And Spectrum Used Items!

BOOKS

- | | |
|--|--|
| QL SERVICE MANUAL-----\$ 10.00 | TS2068 INT/ADV GUIDE-----\$ 3.00 |
| ZX81 BASIC PROGRAMMING-----\$ 5.00 | MC68008 MICROPROCESSOR MANUAL-----\$ 5.00 |
| MASTERING YOUR TS1000/ZX81 COMPUTER -----\$ 3.00 | 2-M68000 PROGRAMMER'S MANUAL-----\$ 5.00EA |
| MC68000 PROGRAMMING POCKET GUIDE-----\$ 5.00 | MTERM TELECOMM BOOK-----\$ 5.00 |
| ADVANCED IN QL MACHINE CODE-----\$ 15.00 | QL TECH MANUAL-----\$ 20.00 |
| THE COMPLETE SPECTRUM ROM DISASSEMBLY-----\$ 20.00 | SINCLAIR SURVIVALIST'S HANDBOOK-----\$ 10.00 |

For above items please use reference # MCU0892

2> NEW! HEADSTART BUS TYPE 3 BUTTON MOUSE-----\$ 45.00EA
 1> TS 2068 IN WOODEN CASE WITH FULL KEYBOARD/PS-----\$ 75.00PP
 HAD SOME DEDICATED KEYS RESET AND MORE/EXTRA KEYS

1> NEW! IN ORIGINAL CARBON!-----\$ 55.00PP
 ZUCKERBOARD 1200B EXTERNAL MODEM

For above items please use reference #CCU1192

CNSN-8 last updated: January 31, 1993

Current Public Domain Price List

Description		Stock #	Price
SUPERBOOT II DISK	(2068) (FD-68)	RMG#0738	3.50
DISK FILE MANAGER PD VERSION	(2068) (FD-68) (PD)	RMG#0562	3.50
SNYDER-CIVIL WAR DIARY	(2068)	(PD) RMG#0741	3.50
BOOK-CIVIL WAR DIARY (SNYDER)		(PD) RMG#0193	5.00
VISTA-PUBLIC DOMAIN DISK #1	(2068) (LarKen)	RMG#0206	3.50
VISTA-PUBLIC DOMAIN DISK #2	(2068) (LarKen)	RMG#0359	3.50
VISTA-PUBLIC DOMAIN DISK #3	(2068) (LarKen)	RMG#0539	3.50
VISTA-PUBLIC DOMAIN DISK #4	(2068) (LarKen)	RMG#0766	3.50
VISTA-PUBLIC DOMAIN DISK #5	(2068) (LarKen)	RMG#0767	3.50
VISTA-PUBLIC DOMAIN DISK #6	(2068) (LarKen)	RMG#0819	3.50
VISTA-PUBLIC DOMAIN DISK #7	(2068) (LarKen)	RMG#0820	3.50
BYTE POWER - D.U.S. UTILITY DISK	(2068) (LarKen)	RMG#0843	3.50
BYTE POWER - D.U.S. MANUAL ON DISK	(2068) (LarKen)	RMG#0377	3.50
CHAMBERS-LKDOS DISK UTILITY PACKAGE	(2068) (LarKen)	RMG#0755	3.50
DOHANY LKDOS PD UTILITY DISK	(2068) (LarKen) (PD)	RMG#1062	5.00
HURD-LARKEN UTILITIES (DISK ONLY)	(2068) (LarKen) (PD)	RMG#0298	3.50
OMNIBUS AOS	(2068) (LarKen) (PD)	RMG#0165	3.50
SWOGER-LKDOS LogiCall V5.0 UPGRADE	(2068) (LarKen) (PD)	RMG#1103	5.00
CHAMBERS-MSDOS TO LKDOS FILE CONVERTER	(2068) (LarKen) (PD)	RMG#0311	3.50
SINCUS PD LIBRARY (3 DISKS)	(2068) (LarKen)	RMG#0422	10.50
LEMKE-PIXEL PRINT PLUS DTP	(2068)	RMG#0438	3.50
LEMKE-PIXEL SKETCH/GRAPHICS EDITOR	(2068)	RMG#0777	3.50
LEMKE-PIXEL PRINT PRO	(2068) (AERC0)	RMG#0937	3.50
LEMKE-TASWORD CONVERSION (DTP)	(2068)	RMG#0776	3.50
EXECUTIVE-SOUND EXPLORER	(QL)	(PD) RMG#0145	3.50
QL PD SOFTWARE DISK	(QL)	RMG#0577	3.50
QL PUBLIC DOMAIN SOFTWARE-PER DISK	(QL)	(PD) RMG#0771	3.00
PSION EXCHANGE SUITE - PD DISK ONLY	(QL)	(PD) RMG#1063	7.50
FINDEX-PC DATA BASE (WOODS)	(PC)	RMG#0305	15.00
MS-DOS PD DISK (EACH)		(PD) RMG#1092	3.00
SPECTRUM EMULATOR FOR IBM COMPATIBLES	(PC)	RMG#1065	5.00

All Prices Subject To Change Without Notice! Subject To Stock On Hand!

Please Check Availability BEFORE YOU ORDER!

February 22, 1994

Return Goods Policy Change, Effective October 1, 1993.

If you purchase new item(s) and they're not what you expected or will not work with your type of computer, we will only take them back if you call for return authorization first! Furthermore, if the item(s) are not in original boxes/packing materials there will be a 50% restockong fee as these items cannot be sold as

new again. If item(s) are in the original boxes/packing materials, the restocking fee is 25%. If item(s) are not working as when shipped to the customer from rmg when they are received back, there will be NO refund! The item(s) in this case will be shipped back to the customer as-is.

MECHANICAL AFFINITY

CATALOG

The following are now available from Mechanical Affinity for your Sinclair home or business computer. Most items listed are available in quantity.

Orders may be placed by check or money order, or International Postal Money order. We do not accept charge cards at this time. Please make all checks out to either Frank Davis or Paul Holmgren.

DO NOT MAKE CHECKS OUT TO MECHANICAL AFFINITY. YOU MAY PLACE YOUR ORDER AT EITHER OF THE TWO LOCATIONS.

For those orders placed in the United States all postage and handling is included in the item price. For Canadian orders please add \$2.00 additional for postage per order. For the rest of the world please add \$3.00 additional postage per order. Sorry for this, but the high price of foreign postage requires us to ask for this.

MECHANICAL AFFINITY
c/o Frank Davis
513 EAST MAIN ST
PERU, INDIANA 46970
Phone 317-473-8031

MECHANICAL AFFINITY
c/o Paul Holmgren
5231 WILTON WOOD COURT
INDIANAPOLIS, INDIANA 46254
Phone 317-291-6002

CHECK FOR NEW PRICES

GOLD CARD FOR THE QL

THIS ALLOWS YOU TO HAVE 2 MEG OF MEMORY, 16 MEGAHERTZ SPEED (up to 4 times the present speed of your QL), AND USE UPTO THREE DRIVES INCLUDING THE 1.4 AND NEW 3.2 MEG DRIVES. HAS FULL TK2 AND EVEN INCLUDES THE CODE FOR OPERATING A WINCHESTER HARD DRIVE (hard drive interface and hard drive not included).

\$360.00

shipped insured, First Class Mail.

Full Trump Card, with TK2, and capable of 2 drives, giving you a drive interface that handles 3 1/2" and 5 1/4" 360K, or 720K drives and RAM memory of 896K..

All for only \$200.00

insured & postage paid.

Add on for QL Trump Card and Gold Card to allow you to use upto 4 drives and latest operating system upgrade. Includes latest version of Tony Tebby's Toolkit II.

\$42.00

NEW FOR THE Z88!

Soft carrying case for the Z88. Protect your notebook sized computer from accidents and the elements. This case is also handy for those with the Laser PC3, Compumate 3 or PC4.

\$10

128K RAM EXPANSION for the Z88, \$50.

512K RAM EXPANSION for the Z88, \$165.

Z88 to MAC CABLES for \$10.

MACLINK EPROM CARTRIDGE, software and cable only \$55.

QLINK, QL to Z88 software, for only \$35.

SERVICES and PARTS

FLP/RAM LEVEL 2, REPLACEMENT EPROM for SuperQBoards (V1.17 onwards, with and without mouse) and all Trump Cards. New manual, real Gold Card compatible subdirectories, about twice as fast on disk access times, and it has the latest TK2, and a new ATR device which lets you access IBM/ATARI disks directly. All for only \$40.

QL INTERNAL ROM BOARD- this allows you to put your favorite ROM version (JM, JS, JSU, MGUS, MGUK, etc.) on an eprom. This will lower power consumption by the QL by about 20% & drop the internal heat by close to 50 degrees Fahrenheit. There is also room on the eprom for us to include one of the following programs if you are an owner of one of them: ICE, QFLASH, TKII, SPEED SCREEN, TKIII. Brd & eprom \$40.00

Board alone \$15.00

Custom eprom alone \$25.00

Let us know which ROM version you want us to supply, or you can supply. We can obtain the latest Minerva for you at current market price. We can also put your own code on EPROM.

INTERNAL BATTERY BACKED CLOCK FOR QL, uses lithium battery, so should be good for far longer than ordinary batteries. This plugs in where the 8032 goes, and the 8032 is then installed in it. board and battery \$20 installed \$26

Medi AFF

QL CASE, contains keys and bare motherboard, no microdrives. Can be used to replace bad case, keytops, or bad motherboard, or even as a start on building your own spare QL \$20

KEYTOPS FOR QL. Use to replace broken or missing keys, or the whole set, if need be. These are originals. \$7.50

5 1/4" DISKS, 360K or 720K, blank name, with Tyvek sleeves 100 disks for \$18.

QL NETWORK PROVER, small circuit in box, gives visual LED indication of when two or more networked QLs are actually working correctly, \$12.

QLs, basic computer, PSION 4 software, power supply, and mini manual.

All of this for only \$85.

TS2068 Computer, manual and power supply for only \$50.

TS2040 Thermal Printer for TS1000 or TS2068, includes paper and power supply \$30.

Sinclair Computing is our Specialty!

TS2068 DOCK EPROM BOARDS, bare \$10.00

These can be used for a TS2068 program on an eprom or can be configured to use for Non-Volatile memory boards (32K to 128K), or as RAM Disk. Let us know if you need docs for these.

Tom Bent's improved 8K TS1000 ROM on EPROM. Requires at least 16K RAM expansion to operate, but bug corrected, some character improvement, improved floating point math, and runs cooler. \$10.00
if we supply the special socket \$12.00

SPECTRUM B ROMs, on eprom, bug corrected w/ additional character set on the eprom, \$10.00

We can supply for those who are owners of the tape programs the following programs on eprom: ZXLR8 for the TS1000, PROFILE for TS2068, MSCRIPT, HOT-Z AROS for TS2068, MTERM II for the TS2068 and DELPHI UTILITIES for the TS1000. (for the eprom) \$10.00

PROFILE for the TS2068 ON PLUG IN BOARD, the best TS2068 database, and it works great with either

disk or tape. Greatly increased command structure and available memory for database. Loads instantly! \$25.00

HOT Z AROS, on cartridge, only a few left, for the TS2068, and for only. Uses dock port of TS2068. \$25.00

QLs REPAIRED AND UPGRADED as per Quantum Levels articles on extending and improving the life of your QL. Basic repair fee is \$35. Sinclair specialty chips, microdrives and membranes extra if needed. Call Paul at 317-291-6002, or Frank at 317-473-8031 for further details.

Sinclair Computing is our Specialty!

BRAND NEW FOR THE QL

MINERVA MK1, the ultimate replacement ROM for the QL. With this you can multi-task SuperBasic programs, do soft resets on the computer, use a dual screen, greatly improved speed, MDV datestamping, and the elimination of many bugs found in the earlier ROMs for the QL. This comes on eprom, with its own board to replace your current ROMs, for only \$62.

HERMES, replacement co-processor for the 8049. This will end any keyboard rollover you may be experiencing; allow you to set the serial output baud rates as high as 19,200 baud, and even set independent baud rates for serial 1 and 2 for input (and after the release of Minerva 1.94 and above you will be able to also do this for output); allows you to use a modem with no dropped characters (even at 300 baud without a modaptor); allow you to toggle ON/OFF the keyboard click; improve the "fuzzy" and "random" sound; and cures the INT7 screen freeze that used to occur, plus the keyboard buffer is increased from 23 to 31 bytes for type ahead. This is the second processor for the QL, after your 68008 and by replacing that 8049 with the HERMES you will note the improvement. All of this for only \$43.

NEW SOFTWARE FOR YOUR QL

We have been engaged in a search of all the newest and the best software from around the world for your QL. The search is not quite over, but here is what we have found so far. If you are looking for something we do not have listed here, give us a call and we will see if we can obtain it for you. We are users of Sinclair and Cambridge computers; thanks for the support!

* FROM EUROPE *

QSPREAD - the dream spreadsheet many QL users have waited for. It runs under the Pointer Environment, either by mouse or keyboard. It is formula oriented, as opposed to Abacus, giving the advantage that it can be modified anywhere. The Parser has 22 scientific functions, along with the standard ones. The size of the spreadsheet is limited only by your memory. Professional quality For only \$89.

QMENU - a very easy to use interface with pre-defined menus (multi-column file-select, simple-choice boxes, or select from lists, error handling). For only \$25.

THE LONELY JOKER - this is a solitaire game based on three different patiences: Echelon, Napoleon, and Cascade. All three games are very addictive, with different variations per game. It can be controlled by either mouse or by the keyboard, and runs under the Pointer Environment. Many people not into games keep coming back! For only \$29.

SER MOUSE - a software driver which allows you to connect up a cheap serial (PC) mouse to one of the serial ports on your QL. Even allows the use of three button mouses. This requires you to provide the mouse and it needs the Pointer Environment, such as QPAC 2, QRAM, or QTOP. For those who have the QIMI (with clock) mouse with Gold Card, you can now remove that and still have a mouse, Gold Card and a battery backed clock in one machine. Not for use with a Microsoft mouse. For only \$37.

QDESIGN, VERSION 2 - the graphic and design program, which now runs entirely under the Window Manager! QDesign handles virtual screens up to 2880 x 2880 pixels in 2 or 4 colors (depending on your memory size), QL- and Atari-Screens, Professional Publisher, Page Designer 2, and ART+ pages. It has a PreView over the whole page, and three zoom sizes. It uses, for the first time on a QL, Vectorfonts, which may be modified in more than one billion ways per font! Configures to print with 9 or 24 pin printers; also HP Laserjets and compatibles. Cost \$89.

THE PAINTER, VERSION 4 - superb quality art and painting program for the QL, pointer driven or keyboard driven. 100% machine code and very user friendly, with both 9 and 24 pin printer drivers. It is also multi-tasking, with all sorts of drawing and text facilities; large text, lines, and fill patterns, etc. Disk only and requires expanded memory. only \$55.

EASY POINTER II - you can create your own PE menus & sprites and use them in your own SuperBasic or machine code programs. Easy to create menus now! Put all of the items you need on screen...and it is done! Supports ALL PE facilities. Many examples included and improved manual. We give you all of this for only \$86.

DISA - this is the intelligent disassembler, which allows you to disassemble interactively any kind of machine code! It is completely pointer-controlled, and very easy to use. It can generate ASCII output which can then be assembled. It will try to insert label names where possible and knows all the QDOS standards. \$52.

QLQ - a software package for those who have 24 pin printers. QLQ is a handy utility that helps you create your own fonts and you get an editor that can be mouse or keyboard driven. It can add BOLD or OUTLINE features to fonts. The fonts can be downloaded and used as either 10 cpi, 12 cpi and proportional. Allows you to use all of the facilities your printer is capable of. Last, but not least, it gives you 13 pre-defined fonts. \$43.

SYSTEM - system tools to use with QDOS. Has real file attributes, such as write-only, hidden or selected user only capabilities. This will work over a network and with a Winchester drive. Also has NEW TRAP #3, new devices, named pipes, MEM, 80 new procedures & functions. Many other facilities to this program! Yours for \$53.

THING AND EPROM MANAGER II - if you need to put your JOBS, THINGS, extensions, SuperBasic or code into EPROM, then this will help you to do so with comparative ease. You will also have the Thing Extension II, which gives you complete control over THINGS from SuperBasic. With this program you will know if something will run from EPROM before you have to burn the chip! For only \$35.

QL-EMULATOR FOR THE ATARI ST - this is a hardware and software package that allows you to transform an Atari 260, 520, 1040 and all Mega's into a QL. With it you can use all the Atari hardware such as accelerators, hard drives and additional RAM. Basic setup for only \$245

Call Frank for more information on this and additional items for this configuration. Updated versions for other Atari Computers available. This allows you to have a superfast QL with hardware not normally available to the QL.

* NEW FROM THE U.K. *

From the birthplace of the QL, we have found some new and exciting software to extend and enhance your QL.

SLOWGOLD - this will allow you to slow down programs or games that run too fast on either a Gold Card, or on a regular QL. It allows you to make these changes either before the program or while in progress. It will not work with games that knock out the 50/60 Hz. Price is \$10.

WINBACK Version 2 - an incremental backup program for the Miracle Hard Disk or for ED drives. You can back up files to any QL device - even on a single drive system. On the first backup you copy everything. Thereafter, only files which have been changed since the last backup need to be copied. Large files can be split across several floppy disks if required. Directory rebuild facility for you if you need to re-format your hard disk. Supports upto 8 hard drives if required. Needs at least 256K RAM. Gold Card ED drive users can use smaller disks for their backups to save money. For only \$46.

MULTI DISCOVER - a clever program that allows you to convert QL files to PC, BBC micros (DFS and ADFS formats), CPM (many formats) and UNIX CPIO format. It will format the disk and much of the process is automatic. Requires dual disk drives and at least 256K RAM. For only \$49.

TEXT'N'GRAPHIX - a program to help you include pictures in your text files when you print them out. Create the text in Quill (or your favorite editor), then use TnG to mark out space in the file for the pictures and print them out. Pictures can be created with programs like The Painter, or from clip art, etc. Runs on both expanded and unexpanded QLs and comes on disk or MDV. \$36.

PAGE DESIGNER 2 CLIPART - Clipart made for PD2, but available in screen format for use in other DTP/graphic programs if required. It has a view facility so you may review the clips a page at a time. \$22.

QPAC 2 - from Tony Tebby, the total upgrade from QRAM, this gives you a top of the line multi-tasking pointer environment, complete with hot keys and buttons. Great for setting up several programs on a HD or ED disk also, so you can have several programs available to multi-task from without changing disks. The price is \$70.

PRINTERMASTER - helps you to master your dot matrix printer with simple menu selection of printer functions. This can save you from having to look up printer control codes. It will even run on an unexpanded QL and can be supplied on either disk or MDV. Many drivers for popular printers are even included, and if not found, you are taken through the steps to create your own printer driver. \$26.

SUPER DISK INDEX - got lots of disks and can not seem to recall what is on what disk? With this program you have a useable index of just what is where, and it has good search facilities. Create a disk that keeps track of all your other disks. For only \$23.

SUPER DISK LABELLER - the easy to use program that allows you to create labels for 5 1/4, 3 1/2 or other size labels with ease. It gives you control over how much and in what format you want the printed label to be. A great buy at \$20.

THE ClipART, by PROGS - some of the very best clip art we have seen for the QL, and three disks full of it, with a viewer. These can be used in your DTP program, art program, screen dumps, or with Text'n Graphix or OverDrive to give you superb graphic effects. For only \$25.

ADDRESS BOOK & LABEL PRINTER - this program gives you a database for your address book, and does not require Archive to run. You can print out address labels in several sizes (minimum size in height is 1-1/2" and on up to 4") and can even use European formats. \$29.

LOCKSMYTHE & FORMATTER, by Zitasoft - this is the best copier and format program known for micro-drive cartridges. If you have a MDV program that needs to be backed up, converted to disk, or an emergency copy made of a protected MDV program... then this is what you need. The best we have found and for only \$47.

QKICK FRONT END SYSTEM - now a simple and easy to master, pull down menu controlled multi-tasking front end. It will run in the background and can be called up at any time. It will give you: notepads, clock, diary, calculator, mini-database, backing up facilities, sophisticated file/sector/RAM handling. For only \$48.

PERFECTION WORD PROCESSOR - from Digital Precision, what some are calling the best word processor ever for the QL. You get superb file, print quality, font style and always available on-line manual. Available also with QTyp for those who need a

spelling checker. Also a version for the Gold Card.
Perfection for only \$117.

Perfection Special Edition with Spellchecker for only \$195.
Perfection Plus with Spellchecker for only \$195.
Perfection Plus Special Edition (for Gold Card) with Spellchecker for only \$276.

SOLUTION - IBM PC emulator for the QL. Runs all well behaved PC programs on your QL, emulates CGA graphics. As it is an emulator, it is slower than the real thing, but it gives you access to many PC programs without buying a new machine. For only \$59.

PC CONQUEROR - The best and fastest PC emulator for the QL and can handle just about any Mono or CGA graphics program. It can even use a disk drive to emulate a hard drive. We have a special version for the Gold Card that can take advantage of those QLs able to run at 24 MHZ, use HD drives and use ED drives as a hard drive. now \$116.
Gold Card Version for \$195.

OUR NEWEST ADDITIONS!

QL CENTRONICS INTERFACE-SER1/SER2 to parallel printer, with a standard centronics plug that defaults to 9600 baud (switchable) and comes with 3 meter cable. All for only \$44.

HERMES CHIP, replacement co-processor for the QLs 8049. This allows you to use a modem on the QL from 300 to 19,200 baud with no modaptor, allows for separate setting of baud rates on SER1 and SER2 so that a printer and modem can operate at different speeds, ends keyboard bounce and improves sound quality on the QL, as well as handles INT7 problems of the QL, and more! Available for only \$43.

MINERVA MK1, replacement ROM for the QL. Along with the HERMES chip, this is the best hardware upgrade you can do for your basic QL. It corrects bugs found in the old ROMs; increases graphic speed and screen speed; allows you to do a soft reset of the computer by key strokes; allows you to multi-task in SuperBasic; allows for dual screens, foreign keyboards and now combined with the latest HERMES chip will allow you to multi-task on your serial ports. Available Now \$62.

JURGEN FALKENBERG HARD DRIVE INTERFACE, with 40 meg hard drive and case with power supply for only \$475.
If you wish the hard drive interface and controller only so that you can add your own hard drive (up to 416

meg!) and case with power supply, then it is only \$310.

This system works with MFM and RLL hard drive controllers. This interface requires a separate bus extender card for your QL, which we have available.
Two slot expander for Gold Card is \$45
the 5 slot adaptor for non Gold Card is \$75.
Contact Frank for further details.

QL KEYBOARD-90 INTERFACE - Allows you to replace the keyboard that came with your QL by using an IBM XT/AT keyboard externally. This is great for those who want to place their QL in a tower or desktop case, or who have just gotten tired of replacing membranes every so often. at a new lower price of only \$100

QUALSOFT TERMINAL SOFTWARE- This is the best terminal program available for the QL and comes on MDV or on disk. It can multi-task with all of the popular QL front ends and has a simple text editor to help with uploads / and downloads and your E-Mail. It allows you to do screen dumps online. Available for only \$45.

BOOKS

SYNCWARE NEWS Vol. 1: All volume 1 issues in one book \$7.

TOURING THE TS2068 ROM OPERATING SYSTEM by WIDJUP \$12.

QL TECHNICAL GUIDE \$15.

QL SERVICE MANUAL \$12.

Extras & New Items

Replacement or backup power supply for the QL, no serious user should be without one. \$15.

Micro Drive Cartridges with tabs, each \$3
without tabs \$2.50

MDV labels, for the QL, 3 sheets for \$1.25.

QL replacement membranes for keyboard \$20.

Rotronics Wafadrive, two 128K stringy floppy drives, parallel and serial printer ports, Spectrum mode only, for \$85.

CW DECODER CIRCUIT

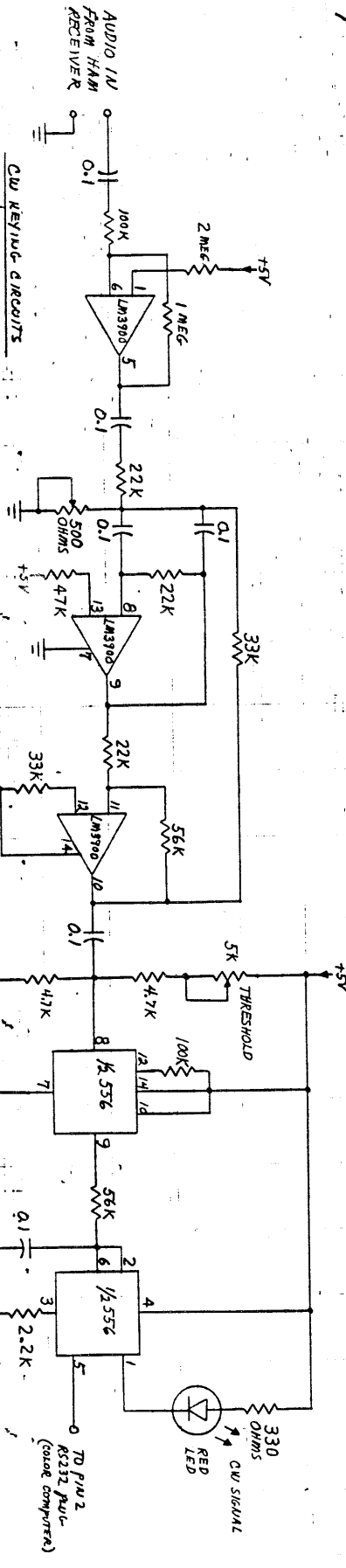

CW KEYING CIRCUITS

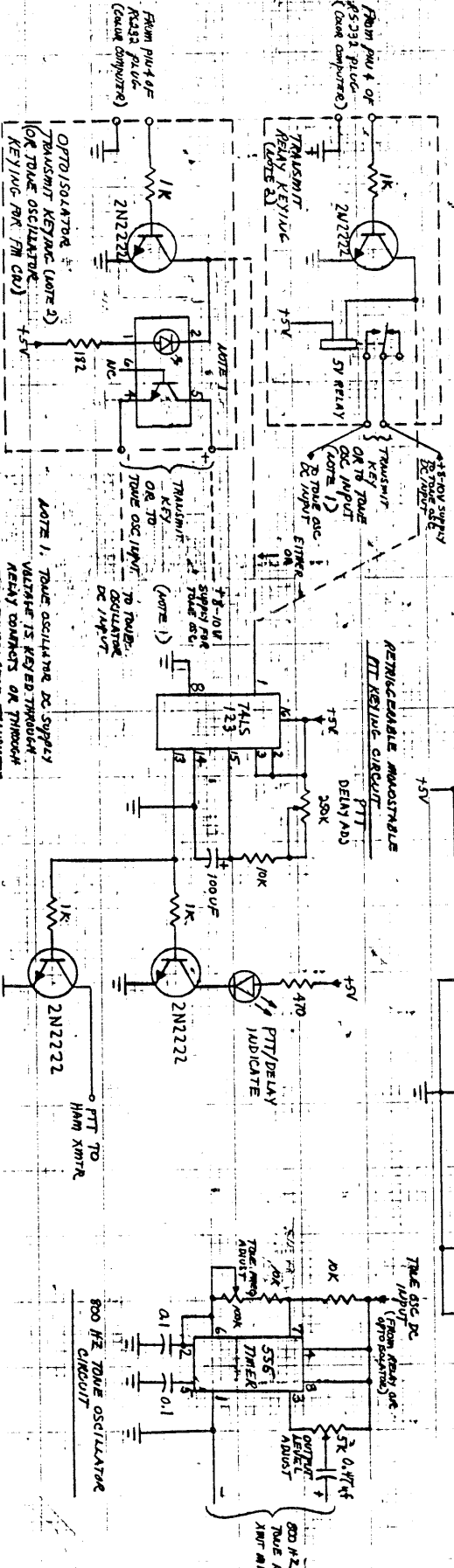

- NOTE 1: TONE OSCILLATOR DC SUPPLY VOLTAGE IS KEYPED THROUGH RELAY CONTACTS OR THROUGH THE OPTO ISOLATOR TRANSMITTER. ALL DC SUPPLY COMMONS ARE TIED TOGETHER AT 800VDC.
- NOTE 2: USE EITHER RELAY KEYING OR OPTO ISOLATOR KEYING BUT NOT BOTH.

FOR GENERATING W04G0H FROM GATEWAY KEYING

Unclassified Ads

Place your ads here, it is free!

Mail to: A. Kahale 335 W. Newport Rd. Hoffman Estates IL 60195-3106

SPECTRUM for your 2068

If you are a LarKen LK-DOS owner and would like to run SPECTRUM programs on your system, we will supply a V2 EPROM, socket and 74HCT32 for \$12 which includes shipping and handling. The installation instructions are in your LarKen manual. We shall not be responsible for your install job. AERCO owners need only the EPROM for \$10 forwarded to LarKen.

Bob Swoger Address on page 2

747 Flight Simulator

So you like to fly, the 747 Flight Simulator for SPECTRUM by Derek Ashton of DACC sold over 40K copies in Europe. Requires a SPECTRUM equipped 2068. At this time supplied on LarKen SSDD disk only for \$10 which goes to Derek now working at Motorola with Bob.

Bob Swoger Address on page 2

PAL Chips

Programmable Array Logic chips are available for some Timex and QL's from:-

NAP_Ware

Nazir Pashtoon
940 Beau Dr. Apt. 204
Des Plaines IL 60016-5876
Phone(eve.) 708 439-1679

Public Domain

XTENDER ZX-81 v.64

by Carlos Delhez

ZX-81 Emulator for PC (IBM clones)
Is available for \$5 pp. on 3.5" 720K or 5.25" 360K disks with 40 page documentation and several titles by Robert Gilbert.

Also SPECTRUM and QL emulators for PCs.

EXCHANGE for QL

(pseudo-multitasking)

by PSION

Is available on DSQD or on 3 DSDD disks. Send your disks with prepaid mailer and you get it for free, or send \$7.50 and we supply the disk and postage

RMG ENTERPRISES

14784 S. Quail Grove Circle
Oregon City, OR 97045

Update

Magazine

Our Only Magazine

513 E MAIN ST
PERU IN 46970
317 473-8031

CONQUEST

A Strategic Generic War Game for the 2068

TIME: A few centuries from now.

PLACE: An unknown inhabited planet.

YOU: Commander of Expeditionary Force.

MISSION: Capture said planet.

INTELLIGENCE: Enemy seen scouting same planet.

STRATEGY: Find and capture Planet's cities.

➤ Can generate new random map every time or play map of your choice.

➤ For 2 or 3 combatants. Play against the computer or your friends.

➤ Production times and fighting ability adjustable for each player - keeps game a challenge at all times.

➤ Completely in fast machine code. Games can be SAVED and CONTINUED.

➤ Available on tape, or disk, AERCO, Oliger. Game and map SAVes in BASIC to allow adaptation to your system. Price \$19.95 + \$2.50 S&H.

Order from:-
Lloyd Dreger
2461 S. 79th St.
West Allis WI 53219

OR
SMUG
Box 101
Butler WI 53007

The John Oliger Co.

11601 Widbey Dr.
Cumberland IN 46229

The John Oliger Floppy Disk System DISK BOARD "A"

Bare PC Board only : \$17.95
Kit of PC Board & parts : \$55.95
Assembled and tested : \$66.95
Two drive cable for above, 3 foot long: \$16.95
Four drive cable for above, 4 foot long : \$26.95
WD1770PH-00 Disk controller chip: \$19.95

DISK BOARD "B"

Bare Board with JLO Safe Disk EPROM : \$26.95
Kit of PC Board with parts : \$45.85
Assembled and tested : \$63.95

PACKAGE OF BOTH DISK BOARDS "A" & "B"

Bare PC Board with JLO Safe EPROM : \$43.95
Kit of both Boards with parts : \$99.95
Both Boards assembled and tested : \$127.95
Both Boards assembled and tested w/2-drive data cable : \$139.95

THE DISKWORKS: Both Boards assembled and tested w/2-drive data cable and assembled 2068 EXPANSION Board : \$189.95

2068 EXPANSION BOARD : plugs in the expansion port on back of 2068. Pass-thru for other peripherals, giving you 4 expansion slots. All devices use this Board, except for the 2068 dock cartridge Board.

Bare PC Board : \$16.95
Board with parts : \$45.95
Assembled & tested : \$56.95

Disk User Manual only : \$5.00 (Read before you buy)

Other available products

2068 User Cartridge board.
2068 EPROM Programmer
2068 Parallel Printer Port
2068/SPECTRUM Joystick Port
DFh Mapped Universal I/O Port board (NEW)
Vpp Power Supply

LISTing Newsletter

Annual dues to receive LISTing is \$16.00. Fred Stern is the editor and is doing great in keeping it going.

LIST

Harvey Rait
5 Peri Lane
Valley Stream NY 11581

WANTED: MINI-MOD AND Z-COM documentation on modem programs for the T/S 1000.

Frederic Stern
P. O. Box 264
Holbrook NY 11741
Tele: (516) 737-0963

WANTED: Looking for instructions or documentation on the ZX Assembler/Diassembler by Bob Berch.

Wayne Knaust
2 Pear Tree Court
St. Peters MO 63376

FOR SALE: Complete TS-1000, TS-2040 printer in their original boxes and three rolls of thermal paper. Mint condition. For \$35 P/shipping.

Complete Atari system, 800XL computer, printer, modem, software and books. Mint condition. \$95 P/shipping

Robert Curnutt
10400 Truxton Rd.
Adelphi, MD 20783

WANTED: A full size keyboard, educational software and a replacement ULA chip for the TS-1000.

Alex Sweitzer
R. D. 1 Box 207
Fayette City, PA 15438

WANTED: Articles or material for the QL and the Z88 for publication in ZXir QLive Alive!. Also articles on any other T/S computer. Can't publish what we do not have. Will accept even handwritten notes.

Donald S. Lambert
1301 Kiblinger Place
Auburn IN 46706-3010

FREEBIE!

Take a look where your disk drive interface cable comes out of the disk case. If you have a sharp piece of metal (all my metal cases had) and want to protect your interface cable from wear here is a deal. I have some plastic protectors that are 3.5 inches long (49 of them) and some that are 2.75 inches long. They are easy to cut to length if necessary (mine all were) and the protector are such that they will slide onto a piece of metal or plastic that is up to about .050 inches thick. To get one or so send a stamped self addressed letter and I will send you up to 3 per request. These were given to me by Paul Holgren to be passed on.

Donald S. Lambert
1301 Kiblinger Place
Auburn IN 46706-3010

FRANK DAVIS
MECHANICAL AFFINITY
513 E MAIN ST
PERU IN 46970
317 473-8031

**Hardware and Software
from around the world**

Z88 QL GOLD CARDS QXL Card
Falkenberg Hard Drive Interface
TEXT78PLUS4
TS Computers

Printers Monitors EPROMs Disks

PAUL HOLMGREN
MECHANICAL AFFINITY
5231 WILTON WOOD CT
INDIANAPOLIS IN 46254
317 291-6002

Repair Service For America's
Favorite Home Computers
And Their Accessories

SINCLAIR

TIMEX ADAM ATARI
IBM OSBORNE TI
COMMODORE

BUY SELL TRADE UPGRADE
Write for prices SASE appreciated

COMPUTER CLASSICS

RT 1 BOX 117
CABOOL MO 65689
Phone 417 469-4571

MIRACLE 512K EXPANDERAM	\$60
TRUMP FLP/RAM	\$35
TRUMP2 DISK CARD (0)K I/O	\$60
ALL THREE FOR	\$120

Includes a copy of Qluster, QLuMsi and
QLamber.

Al Feng

*914 Rio Vista
Circle SW
Albuquerque,
NM 87105
(505) 843-8414*

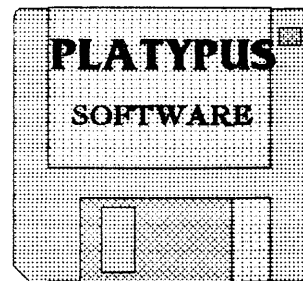

Make David an Offer

ZX-81 TS-1000
TS-2068
Hardware

BYTE-BACK INC.

536 Long Terrace
Leesville SC 29070

Word Processing

TS-TEXT 2000™
ZX-TEXT™

ZX-81 TS-1000
TS-1500 TS-2068

Albert F. Rodriguez

A.F.R. SOFTWARE®

1605 Pennsylvania Ave. #204
Miami Beach FL 33139
305 531-6464

WANTED: Where can I get plain white cassette
tape labels? The kind with the hole in the center.

D. G. SMITH
R. 415 STONE ST.
JOHNSTOWN PA 15006

WANTED: 64K RAMPACK (prefer Memopak
but any would be considered); HOT Z, DE-
BUGGER, ASSEMBLERS for the TS-2068;
HUNTER BOARD for the TS-1000.

WAYNE KNAUST
2 PEAR TREE CT
ST. PETERS MO 63376

GATOR's TWISTED PAIR

!! S I N C L A I R B B S !!
We have a 24 hour BBS and encourage you to exchange mail and contribute to the Download Section. Use it and have fun!!

Call 708-632-5558 and Register using your first name, last name and phone number along with a password you won't forget, and WRITE IT DOWN! Do not try to do anything else this first time because all the board options will be locked out.

When you call in the next time, you will have Level 5 security and be able to enjoy full user privileges. The BBS has subdivisions of smaller sections called conferences. Select 'J'

for 'Join a Conference' to see the different user groups. Select 'TIMEX' to get into the Sinclair Section. The mail you then read there will only be from other TIMEX/Sinclair users but all SIGs share the same bulletins.

Bob Swoger, SYSOP ----GATOR----
TimeX/Sinclair NorthAmerican
User Groups

FOR SALE: Olivetti PR22300 Ink-Jet Printer new in original box with extra cartridges, \$100.00; Radio Shack CGP-115 Color Graphics Printer/Plotter, \$100.00, also extra Owners Manual for CGP-115, \$7.50; T/S 2050 Modem complete, new in original box, make offer.

D. G. SMITH
R. 415 STONE ST.
JOHNSTOWN PA 15906
TELE: (814) 535-6998.

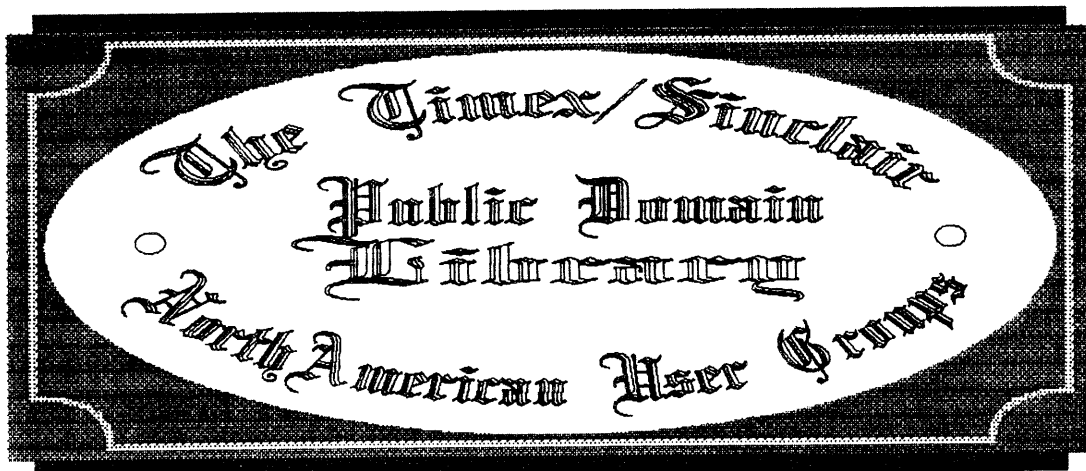

VISTA PD Library Tapes 1 - 4 & Disks 1 - 5 (Description is in the Winter 1993, Vol. 3, No. 4)

Disk No. 6	Pixel Print Plus	by Stan Lemke (instructions on disk)
Disk No. 7	Sting Graphics	by Steve Spaulding
Disk No. 8	Utilities & Music	Music by Joan Kealy RecordKeeping by A. Kahale
Disk No. 9	Program Utilities	by George Chambers TTSUC
Disk No. 10	Byte Power	Disk Utilities Software by Christian Boisvert
Disk No. 11	Manual for	Disk Utilities Software

SSDD or DSDD LKDOS disks are available for \$3.50 each PP. From:

A KAHALE
335 W NEWPORT RD
HOFFMAN ESTATES IL 60195-3106

C-60 Tape or JLO DISKS are available from:

D G SMITH
R 415 STONE ST
JOHNSTOWN PA 15905